

USER'S MANUAL HAKI BRIDGE SYSTEM (HBS)



Important information

HAKI's product liability and user's manuals apply only to scaffolds that are entirely composed of components that have been made and supplied by HAKI.

HAKI's scaffold systems must not be erected using components of makes other than HAKI or be connected to scaffolds of makes other than HAKI. In such cases, a special study of load-bearing capacity must be carried out. However, HAKI has no objection to the customary addition of scaffold tubes and approved couplers to the scaffold.

Adding components from different suppliers may invalidate the insurance cover.

HAKI reserves the right to make technical modifications on a continual basis.













This user's manual is to be used in conjunction with HAKI training courses.

The latest versions of HAKI user's manuals can be downloaded from our website, www.HAKI.com.

For scaffold structures that are not covered by this user's manual, please contact HAKI's technical department.

HAKI colour code

Horizontals and diagonals are marked with their nominal sizes (bay sizes) and a colour code. The marking is a useful means of identification when erecting and handling the scaffold material.

564		1050		1964		3050	
700		1250		2050			
770		1550		2500			
1010		1655		2550			

Forces and dimensions

1000 N = 1 kN ~ 100 kg

10 N ~ 1 kg

All measurements in mm

© Copyright HAKI AB, 2022

The reproduction of text and pictures/illustrations without HAKI's permission is prohibited.

HAKI Bridge System (HBS)

The HAKI Bridge System (HBS) is designed for loadings up to 7.5kN/m². The HAKI Bridge System is designed to be used as a pedestrian bridge over rail tracks/roadways and similar projects, to act as a spine beam for scaffolds, or to support temporary roofs. It is a perfect complement to the HAKI Public Access Stair (PAS).

All HAKI Systems have been designed to conform to current British and European Standards. The loading criteria contained in this manual have been calculated according to current European Standards, SS-EN 12810 and SS-EN 12811.

General

The HBS incorporates the use of HAKI Universal system components including single ledgers, ledger beams, and guardrail frames. The handrails are specially designed for use on a HBS and PAS system. All components for the HAKI Bridge System are hot-dip galvanized with the exception of the insert panels and AL planks.

The HBS can be erected in bay widths of 1250mm, 1655mm, 1964mm or 2500mm (where permitted) and bay lengths of 2500mm or 1250mm with the minimum of tools.

The HBS may be constructed;

1. on a temporary scaffold at ground level, then lifted into place.
2. on a temporary scaffold at finished level.
3. by a progressive 'roll-out' method.





Marking

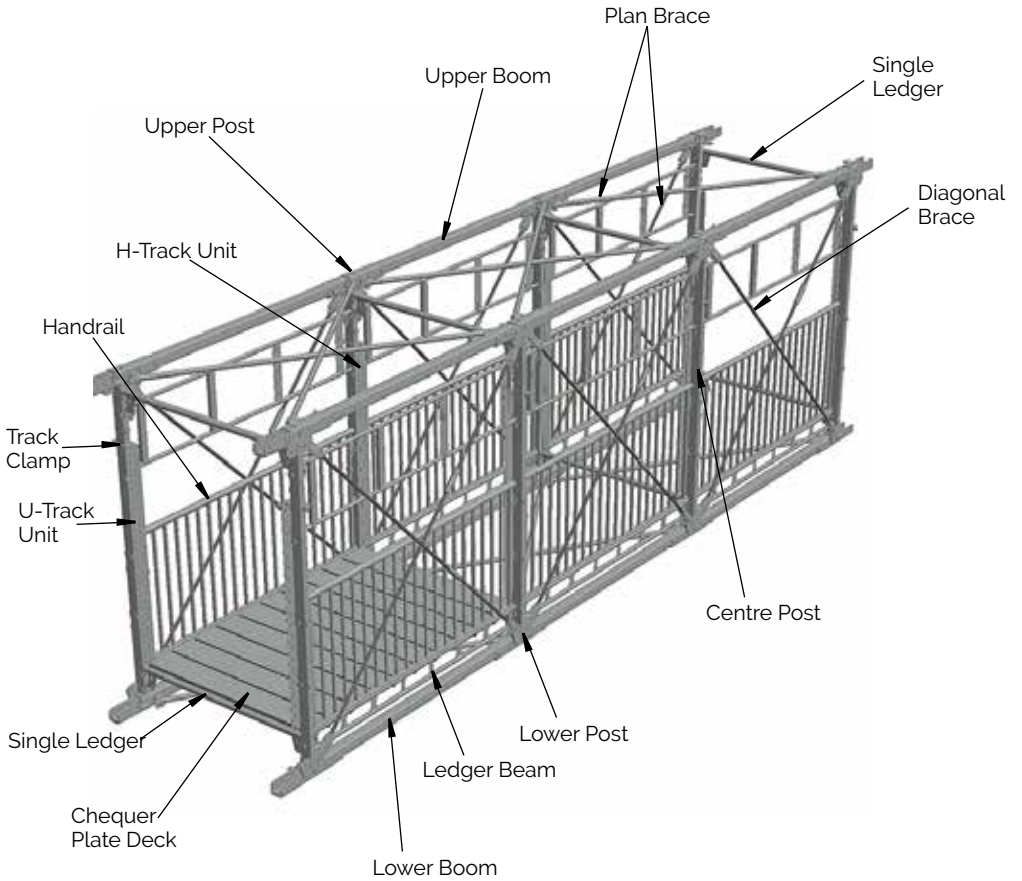

All components, with the exception of locking catches, pins etc, come permanently marked with the HAKI logo and the last two figures of the year of manufacture (■ S22).



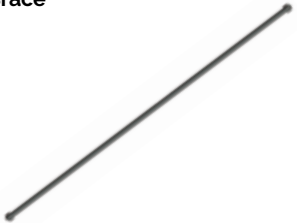

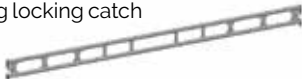
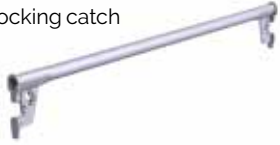
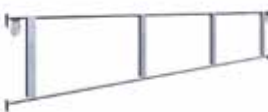

All load bearing components are marked for full traceability.



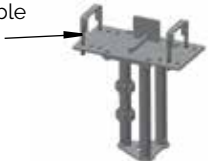



	 IMPORTANT! ENGAGE LOCKING CATCHES AS EACH COMPONENT IS FIXED	
---	---	--







Name		Code	Item No.	Weight(kg)
HBS Post		Upper	7104109	21.5
		Centre	7104140	16.0
		Lower	7104108	23.6
HBS Upper Boom		1250	7104135	10.9
		2500	7104118	23.2
HBS Lower Boom		1250	7104136	12.5
		2500	7104130	26.8
HBS Plan Brace		1250 x 1250	7105121	4.4
		1250 x 1655	7105161	5.0
		1250 x 1964	7105191	5.7
		1250 x 2500	7105251	6.8
		2500 x 1250	7105126	6.8
		2500 x 1655	7105195	7.4
		2500 x 1964	7105197	7.8
2500 x 2500	7105199	8.7		
HBS Diagonal Brace		1250	7104138	14.5
		2500	7104119	17.0

Name	Code	Item No.	Weight(kg)
Landing Handrail 	1250	7053125	19.5
	2500	7053250	34.2
Ledger Beam LBL With spring locking catch Ø34mm 	1250	7021122	6.5
	1655	7021162	6.7
	1964	7021192	8.0
	2500	7021252	10.9
Single Ledger ERB With spring locking catch Ø48mm 	1250	7022121	5.1
	1655	7022161	6.3
	1964	7022191	7.3
	2500	7022246	8.9
Guard Frame GFL With spring locking catch 	1250	7052124	5.7
	2500	7052254	9.2
Ledger with lock (anti-vandal) 	1250	7104124	5.1
	1655	7104164	6.3
	1964	7104192	7.3
	2500	7104254	8.9
Adjustable Ledger Adjustable 647-1010m 	647-1010	7053005	4.1

Name	Code	Item No.	Weight(kg)
HBS Tripod Head Adapter incl. Clamps Top plate is detachable to be re-fitted in opposite hand 		7104111	27.5
HBS Clevis Pin (With 1 clip) 	20 x 125 20 x 70 16 x 90 R-Clip	2113010 2113012 2113011 6130203	0.3 0.2 0.2 0.0
Bult & Nut 	M20 x 80		0.0
Tripod Adapter 60 G 		7203312	11.6
Tripod 	500 1000 1500 2000 3000	7203340 7203341 7203344 7203342 7203343	10.0 17.3 23.3 31.8 45.8
Tripod Base Jack 60 G 		2071061	15.6

Name	Code	Item No.	Weight(kg)
HBS Checker Plate deck 	1250 x 200	2140125	13.1
	1250 x 250	2140126	14.9
	1655 x 200	2140165	17.4
	1655 x 250	2140166	19.7
	1964 x 200	2140195	20.6
	1964 x 250	2140196	23.4
	2500 x 200	2140255	26.2
2500 x 250	2140256	29.8	
Aluminium Deck 	1250 x 200	2153125	5.0
	1655 x 200	2153165	6.2
	1964 x 200	2153195	7.1
	2500 x 200	2153255	8.7
	1250 x 295	2153124	6.1
	1655 x 295	2153164	7.5
	1964 x 295	2153194	8.6
	2500 x 295	2153254	10.5
HAKI Steel Deck 	1250 x 230	21521250	7.7
	1655 x 230	21521655	9.9
	1964 x 230	21521964	11.9
	2500 x 230	21522500	14.8
Insert Panel 	1250 x 230	2171250	5.9
	1655 x 230	2171655	7.7
	1964 x 230	2171964	11.5
	2500 x 230	2172500	14.5
HBS Sway Brace 	4000	7104141	15.3
Intermediate Transom 	1250	7204122	6.3
	1655	7204162	7.8
	Adjustable: 1655/1964/2500	7204164	12.7

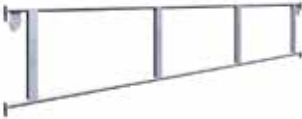
"Roll-Out" method accessories

Name	Code	Item No.	Weight(kg)
750 Frame AL 	1250	4032125	9.4
	2250	4032225	16.6
	3250	4032325	23.9
	6250	4032625	46.0
750 Straight Connector 		7203001	2.0
Spring Pin Ø 12 mm 		2113100	0.1
Guard Frame GFL 	1655	7052164	7.4
	1964	7052194	8.1
	2500	7052254	9.2
	3050	7052304	10.5
750 Plan Brace AL 	1250 x 1250	4122121	2.7
	1250 x 2000	4122123	3.0
	1250 x 2250	4122124	4.0
	1655 x 1250	4122162	3.4
	1655 x 2000	4122163	3.3
	1655 x 2250	4122164	4.0
	1964 x 1250	4122192	3.7
	1964 x 2000	4122193	4.3
	1964 x 2250	4122194	4.6
	2500 x 1250	4122249	4.4
	2500 x 2000	4122254	4.9
	2500 x 2250	4122253	5.1
	3050 x 1250	4122299	5.0
3050 x 2000	4122303	5.5	
3050 x 2250	4122304	5.6	
HBS Erecting Roller 		7104143	6.0

Name	Code	Item No.	Weight(kg)
HBS Jacking Bracket 		7104142	17.5
Bottle Jack Supplied by customer 			
750 Rolling Roof Wheel Adjustable G 		7142006	15.0
Base Jack BS Adjustable 55-570 mm 		2071000	5.0
Standard S Standard joint with spigot Pockets at same level Ø 48 mm 	1000	7016100	5.3
Diagonal Brace DS With wedge couplers Ø 48 mm DS 1655 L=2235 DS 1964 L=2473 DS 2500 L=2917 	1655 1964 2500	7122164 7122194 7121254	10.1 10.9 12.6

Name	Code	Item No.	Weight(kg)
Ledger beam LBL With spring locking catch Ø 34 mm	1250	7021122	6.5
	1655	7021162	6.7
	1964	7021192	8.0
	2500	7021252	10.9
	3050	7021302	12.3



Beam rider BRS For ledger beams With locking screw		7208020	2.0
---	--	----------------	-----



HBS Cladding System accessories

Name	Code	Item No.	Weight(kg)
HBS Cladding Panel	1250 x 250	2033120	2.0
	1250 x 500	2033122	4.0
	2500 x 250	2033250	4.0
	2500 x 500	2033252	8.0



HBS H-Track Unit		7104132	7.0
-------------------------	--	----------------	-----



HBS U-Track Unit	Left	7104129	3.5
	Right	7104131	3.5



HBS Track Clamp		7104133	0.5
------------------------	--	----------------	-----



For other accessories, see HAKI Component List.

Information on safety when erecting and dismantling

1. Before erecting or dismantling a scaffold, the working area should be fenced off where possible.
2. The location for the scaffold must be checked in order to prevent risks when erecting, dismantling and moving the scaffold and to ensure that work can be carried out safely with regard to level and slope, obstacles and wind conditions.
3. Make sure that all lifting equipment to be used, e.g. chain hoists, lifting ropes, pulley blocks, etc., has been thoroughly tested and approved by an authorized person in accordance with local regulations.
4. Check that tools and protective equipment are available at the worksite.
5. Wear appropriate personal safety equipment at all times, e.g. safety harnesses, proper independent lifelines with suitable fixings, etc.
6. When erecting and dismantling a scaffold, robust temporary decking must be used as temporary platforms for the scaffolders.
7. Always make sure that the safety locking devices that prevent a platform lifting off have been activated once a platform has been installed.
8. Study all relevant instructions or safety directions from the manufacturers of the various scaffolds that are to be used.
9. Never climb up a scaffold from the outside. Always use the stairs, ladders or climbing frames that are designed to provide access to the upper decks from the inside of the scaffold.
10. If the scaffold is located outdoors, erection or dismantling work must be discontinued in severe weather conditions. All loose components and materials must be secured prior to leaving the scaffold.
11. All scaffolding work must be undertaken by competent operatives under the supervision of a competent person.
12. Raising and lowering of parts, material and tools using ropes or slings must be carried out in a protected lifting area.
13. Lifting equipment must not be fitted to scaffolding unless ties or equivalent devices are secure.
14. Beware of any overhead power lines nearby.
15. Always observe and comply with the regulations issued by the local authorities concerned.
16. Operatives should always be clipped to a single ledger or ledger beam during erection/dismantling. Reference should be made to the "Personal Safety Equipment" section in the HAKI Universal User manual.

Before erecting the scaffold, check and flatten out the ground. Check the levels in both the transverse and longitudinal directions using a spirit level and adjust using the base jacks.

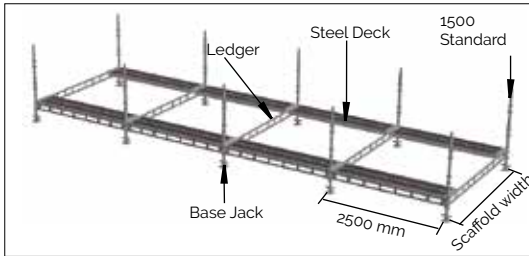

1. Construct low scaffold of sufficient width to comfortably walk around the HBS.

HBS Width	Scaffold Width
1.25m	1.964m
1.655m	2.5m
1.964m	3.05m
2.5m	2 x 1.655m

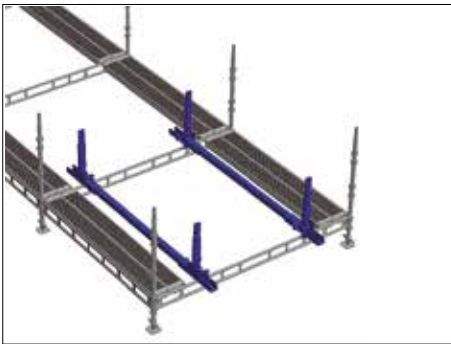

2. Install lower post units with lower booms using $\varnothing 20 \times 125\text{mm}$ clevis pins and R-clips.

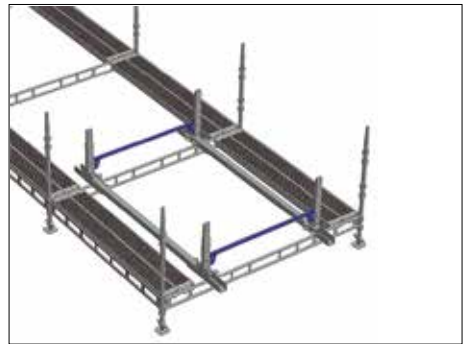

3. Install appropriate size single ledgers as transoms.

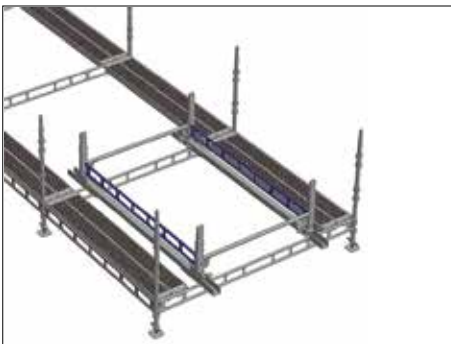

4. Install ledger beams between lower post units.

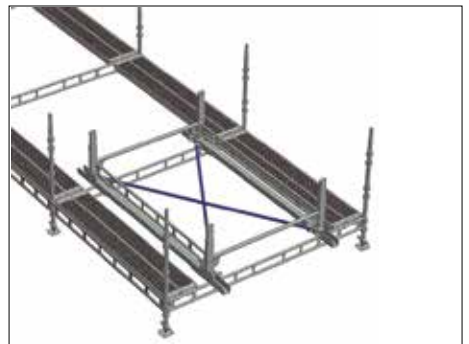

5. Install plan braces between lower post units using $\varnothing 16 \times 90\text{mm}$ clevis pins and R-clips.

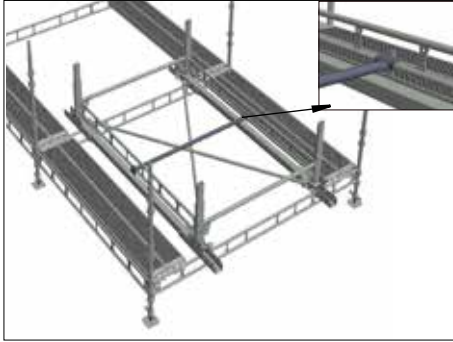

6. Install an adjustable intermediate transom with adaptor 35 inserts to the centre of the ledger beam bottom chords, to avoid the ledgers from spreading apart due to vibration (transom is not necessary if AL decks are used on the HBS).

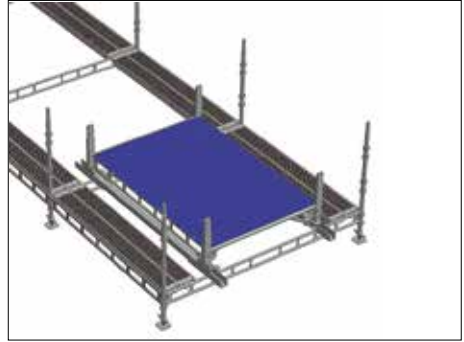

7. Install the chequer plate decks.

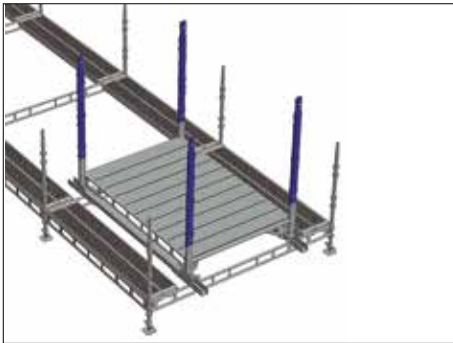

8. Install the central sections of the posts and secure with M20 bolts and nuts (hand tighten only).



9. Install side handrail units and a temporary guardrail frame at front of assembly.



10. Install the upper post units and secure with M20 bolts and nuts (hand tighten only).



11. Install guardrail frames around all 4 sides of the HBS bay.

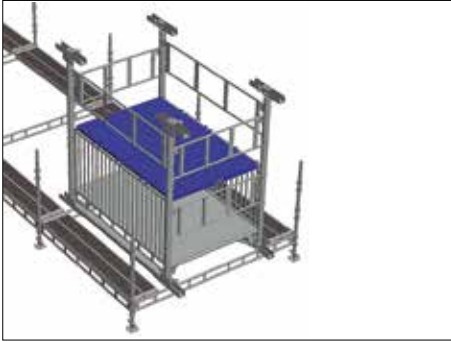

12. Install the erection platforms to the top of the handrails, and access to the temporary platform.

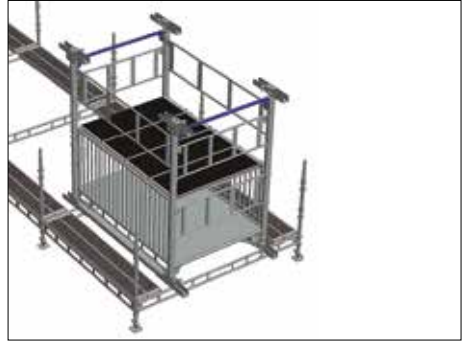

13. Install upper single ledgers between upper post units.



14. Install upper booms with $\text{Ø}20 \times 125\text{mm}$ clevis pins and R-clips.



15. Install upper plan braces with $\text{Ø}16 \times 90\text{mm}$ clevis pins and R-clips.

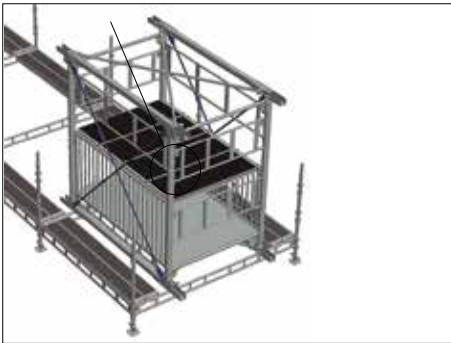

16. Install HBS diagonal braces, 2 per side using $\text{Ø}20 \times 70\text{mm}$ clevis pins and R-clips. Adjust tension in braces to hand tight only.



17. Remove all the temporary guardrail frames and erection platforms.

Use the removed components to erect the next bay of the HBS.



18. Repeat stages 2-17 for remaining HBS bays.

Once bridge has reached required length tighten all fixings (handrails, bracing, vertical posts).

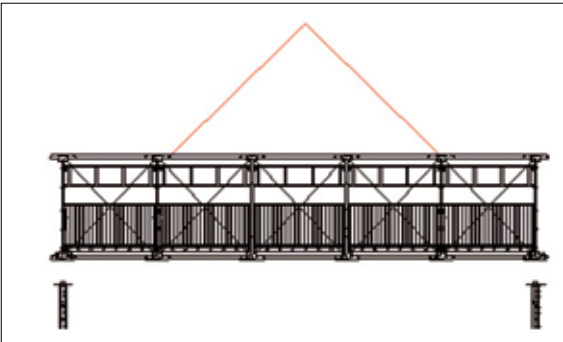

19. In accordance with Lifting Plan, attach slings and lift to allocated position on tripod legs.

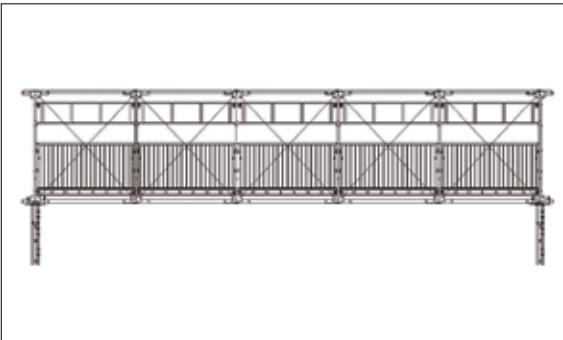

20. Fit clamps to tripod head adapter and remove lifting equipment.

NOTE: Clamps should not be OVERTIGHTENED. Bridge should be permitted to 'slide' in its longitudinal direction.

Refer to End fixing, Connection to end structure, and Bracing details on page 22 and 23 of this manual.

PLANLAYOUT

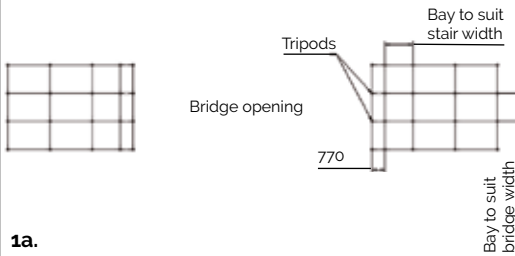

1a.

1a. Erect scaffolds of sufficient area at each side of bridge opening.

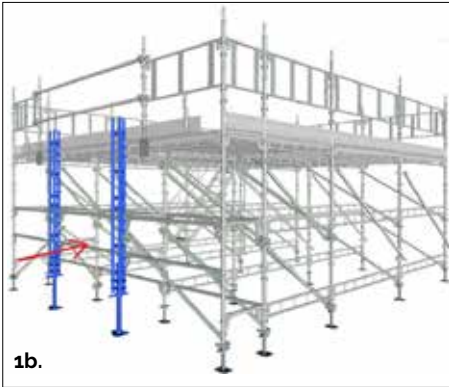

1b.

1b. Install tripods in front of the scaffold (on the bridge bay). Tripods below the head adapters must be at least 1.0m. The Tripod pockets must be facing the scaffold.

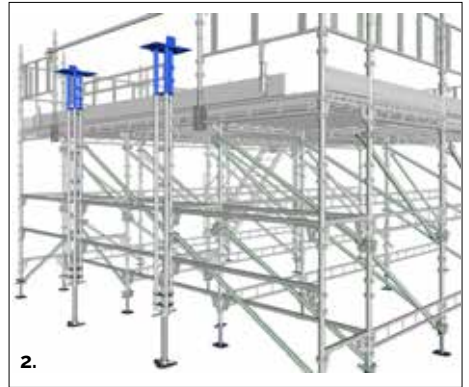

2.

2. Install tripod head adapters onto the tripods. NOTE: Do not install the head adapter clamps until bridge is in final position.

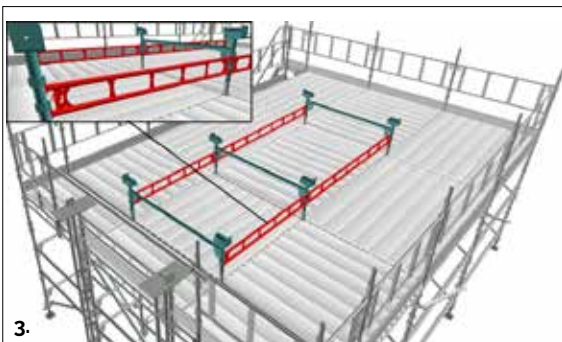

3.

3. Install 6 erecting rollers on the exposed standard spigots, and secure using pins. Install single ledgers and ledger beams to lace the rollers together.

NOTE: Ledger beams (in red) must be installed upside down to act as an uplift restraint.

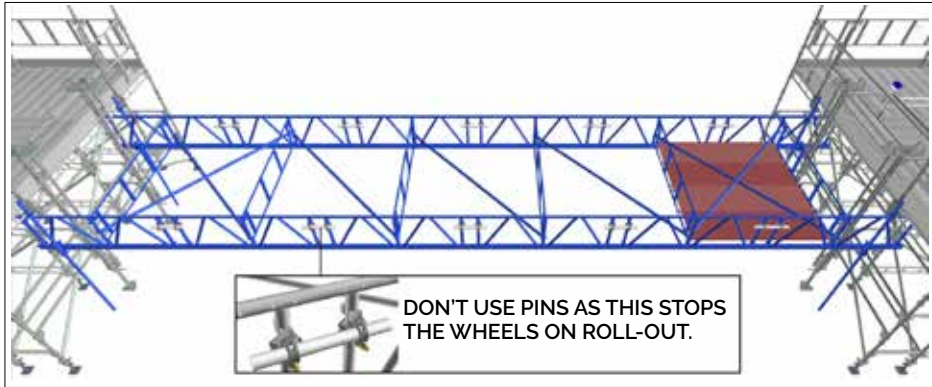

4. Install HAKITEC 750 beams 1m below the scaffold top lift. Lace and brace them together with the aid of walkboards. End bays must be cross-braced. On top chord of the beams, straight connectors must be installed without pins to avoid clashing with the roll out wheels. All connections must be tied together using tube & fit as shown.

HBS Width	750 Beams Width
1.25m	1.655m
1.655m	2.5m
1.964m	2.5m

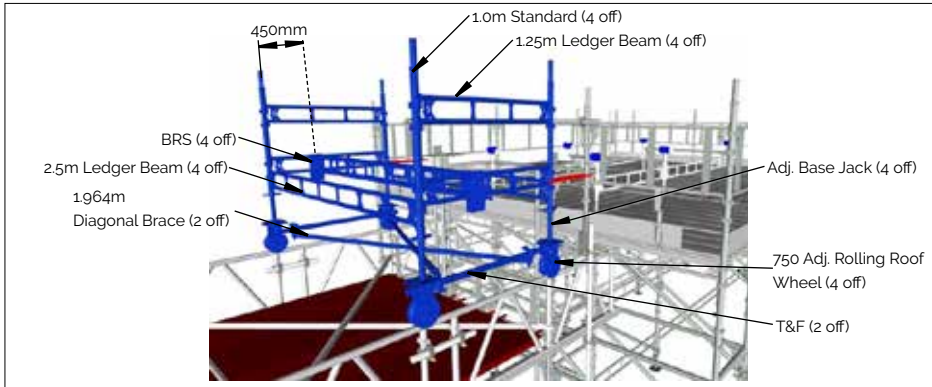

5. From the walkboards, assemble the trolley on 750 Beams. Secure the trolley to the main scaffold using ratchet straps.

HBS Width	Trolley Width
1.25m	1.655m
1.655m	2.5m
1.964m	2.5m

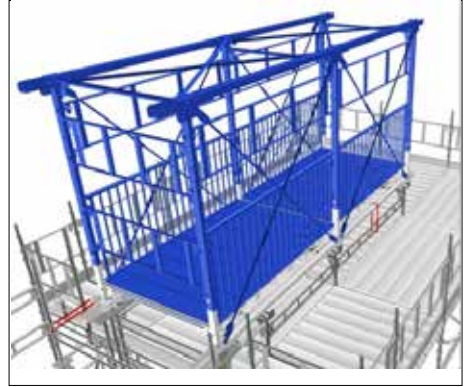
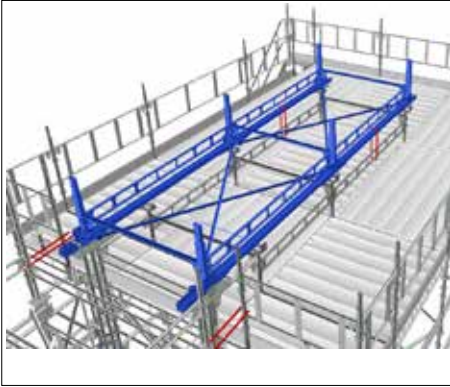

6. Install the first two HBS bays on the rollers, using steps 2 to 6 of the "erection by lifting" procedure in this manual (pg.13&14). Secure the lower boom to erecting platform ledger beams using ratchet straps.

7. Repeat steps 7 to 17 of the "erection by lifting" procedure in this manual (pg.14&15). Do not dismantle the front guardrail frames.

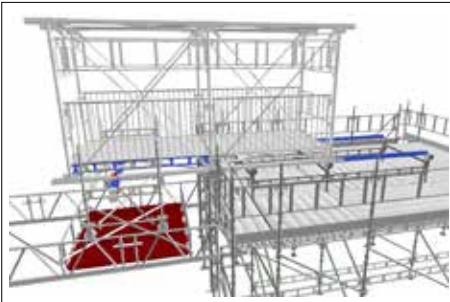

8. Release ratchet straps and roll bridge section forward using the lower booms. Roll the bridge out until the third plate of the leading edge bay ledger beam is above the ledger beams on the trolley. Replace uplift ratchet straps to the erecting platform and secure the bridge to the trolley using additional ratchet straps.

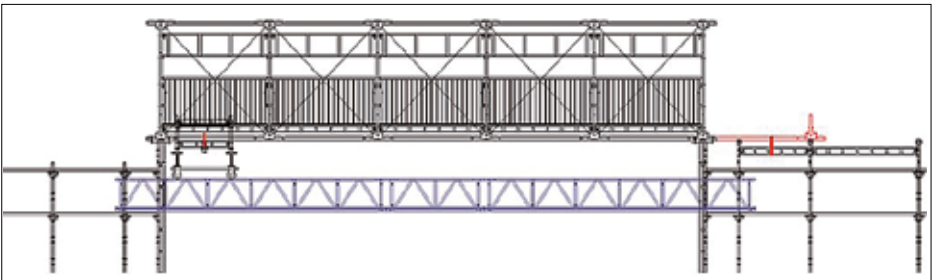

9. Complete the third bay and repeat steps 6 to 8 until the bridge has reached the required length. Install additional lower booms at the rear of the bridge to move the bridge to its final position. Re-strap the lower booms to the erection platform.

Lowering Bridge to its final position.

The following procedure should be performed from the safety of the main scaffold.

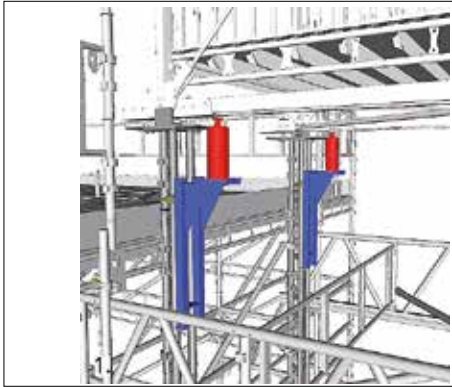

1. On the leading edge of the bridge install jack brackets on the head adaptor and tighten the couplers to secure. Install the bottle jacks on the jack brackets. **Trolley omitted for clarity.**

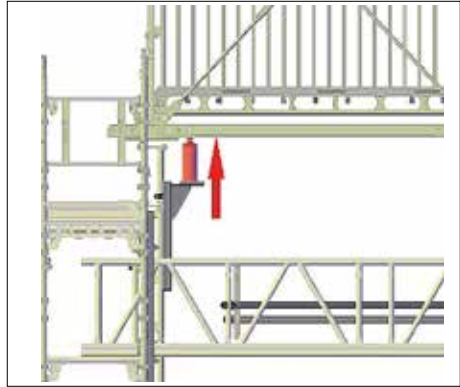

2. Release ratchet straps from the trolley and bridge bay. Using the bottle jacks, raise both sides of the bridge in unison by 30mm. **Trolley omitted for clarity.**

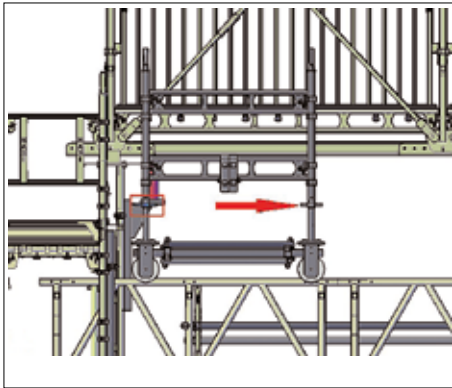

3. Lower the front trolley base jacks and push the trolley away.

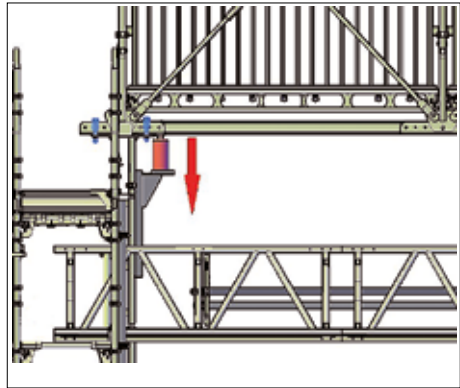

4. Using the bottle jacks, lower both sides of this end of the bridge into final position at the same time. Fit clamps to tripod head adaptor. NOTE: Clamps should not be OVERTIGHTENED.

5. Remove end 1.655m guardrail frames from bridge. Dismantle the trolley from the safety of the access platform. Repeat steps 1,2 and 4 in this procedure(pg.20) on opposite side of the bridge to remove the temporary lower booms. Once bridge is in its final position, tighten all fixings (handrails, diagonal bracing, and vertical posts).

Refer to End fixing, Connection to end structure, and Bracing details on page 22 and 23 of this manual.



1. Install U-Track Units in the end bays.



2. Install H-Track Units in the middle bays.

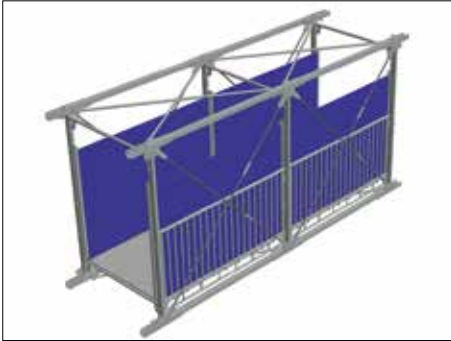

3. Install Cladding Panels between Tracks.

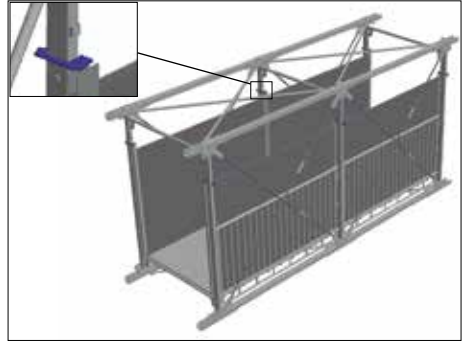

4. Secure all the Tracks in place installing a Track Clamp per Track Unit.

End Fixing

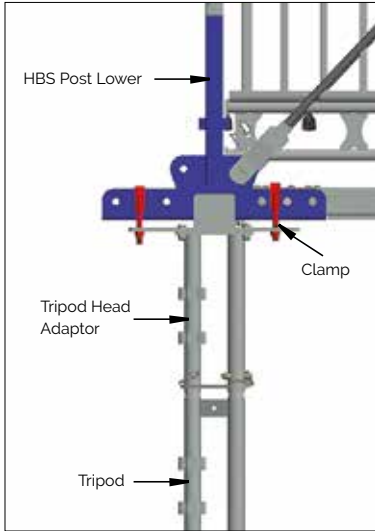

End HBS post-Lower to be positioned centrally over Tripod Head Adaptor.

Clamps should be fitted in most convenient holes in head plate and nuts tightened.

! NOTE: Clamps should not be OVERTIGHTENED. Bridge should be permitted to 'slide' in its longitudinal direction.

Connection to End Structure

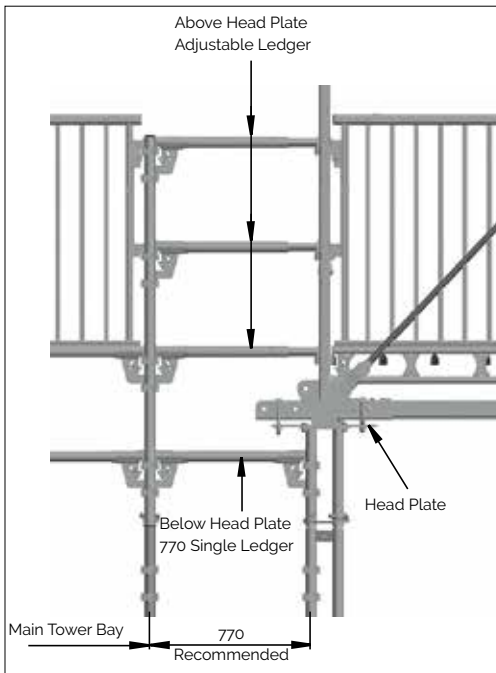

Adjustable Ledgers should be used above the Head Plate of the Tripod Head Adaptor.

Below the Head Plate a 770 single ledger should be installed in the first set of pockets. 770 single ledgers are then installed at alternate sets of pockets (1m centers) of the Tripod leg.

! NOTE: If the HBS system is used near a railway it is essential that the HBS is connected to the main structure (PAS) at each end using Adjustable Ledgers.

This allows the HBS to move in its longitudinal direction so that natural horizontal effects are not transmitted into the main structure.

Bracing

At each end of the bridge, install Sway Braces to Upper Posts using M16 bolts & nuts and to adjacent scaffold structure at lower ends using load bearing couplers to provide lateral stability.

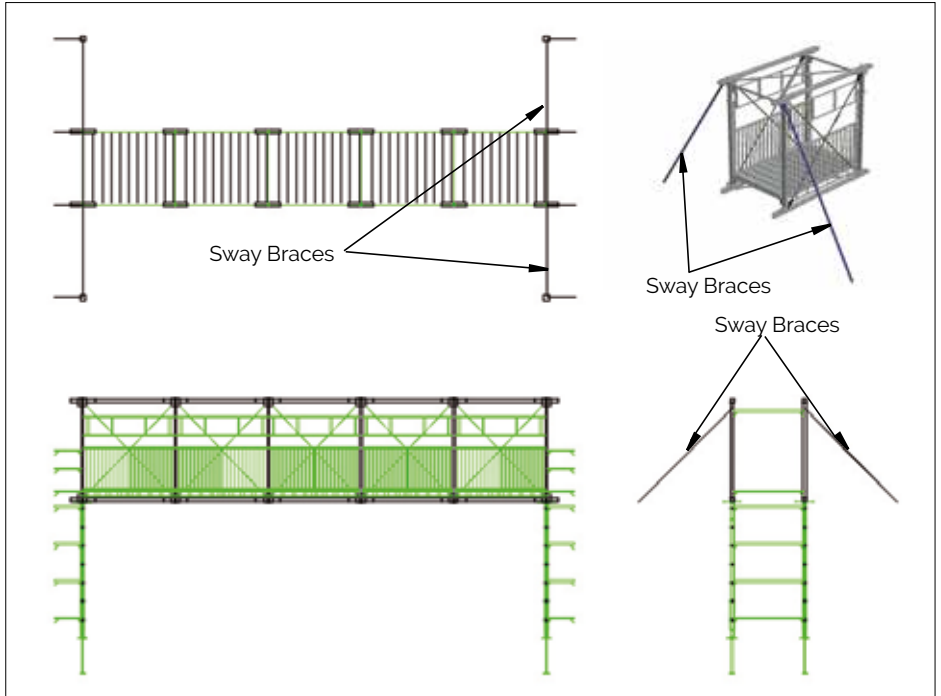

Information on safety when dismantling

1. Do not throw or drop materials to the ground. This may damage the material or cause personal injury. The materials must be lowered down to the ground by means of ropes or slings or passed down by hand.
2. Always observe and comply with the regulations published by the local authorities concerned.
3. Operatives should always be clipped to a single ledger or ledger beam during dismantling.
4. Dismantle the HBS in the reverse order of the erection procedure.
5. Reference should also be made to section "Information on safety when erecting and dismantling" on page 12 in this manual.



15m HAKI Bridge System



Experience

With over 60 years experience to call on, HAKI has gained a leading reputation in its field. With its own R & D and manufacturing facilities, the company now operates throughout Europe and its equipment is in use worldwide. With all products designed and manufactured to ISO 9001:2015, and a comprehensive training and support infrastructure, you can rely on HAKI for support.



Training

The Company's dedicated Training Centre is equipped with the full range of HAKI products where a comprehensive choice of courses is offered. With the benefit of this training, all users of HAKI products can be assured that the equipment is being employed safely and effectively.



Support

From computerised estimating facilities to on site assessment and project back up, HAKI is with its customers every step of the way. Working with HAKI means far more than just proven equipment, it means working with people who understand the scaffolding industry. Whatever the project, the company is committed to ensuring every user enjoys the full benefits associated with the use of HAKI - maximising the savings, profitability, and above all, SAFETY.

Health and Safety at Work Act, 1974

HAKI equipment is designed to meet the requirements of the above Act, Section 6.

It is also the customer's responsibility to comply with the requirements of this Act, particularly to use the equipment in accordance with current codes of practice and in ensuring that components are in good working condition prior to each use.

We are able to provide assistance and advice on matters relating to safe and proper use of HAKI equipment.

