

# HAKI Komponentliste NO

## Innhold

HAKI UNIVERSAL	3
HAKI UNIVERSAL S4 ALUMINIUM	21
HAKI UNIVERSAL S6 ALUMINIUM	24
HAKI UNIVERSAL APPLIKASJONER	26
HAKI RAMME	38
RØR OG KOPLING	43
HAKITEC 750 VÆRBESKYTTELSE	44
HAKITEC INNDEKKNING	51



TYPKONTROLLERAD  
Arbetsmiljöverkets  
krav AFS 2013:4



HAKI forbeholder seg retten til løpende tekniske forandringer.

© Copyright HAKI AS, 2024

HAKI AS • Postboks 444, 3002 Drammen, Norway • +47 32 22 76 00 • info@haki.no • www.HAKI.no

**Bunnkomponenter**

	Kode	Utfør.	Art. nr	Vekt
<b>Bunnskrue</b>	BS	G	<b>2071000</b>	5,0
Justerbar	BSL	G	<b>2073003</b>	9,2
BS=55-570 mm				
BSL=40-650 mm				

**Spirer**

		Utfør.	Art. nr	Vekt
<b>Spire S</b>	S 500	G	<b>7016050</b>	2,9
Spireskjøt med tapp Ø 38 mm	S 1000	G	<b>7016100</b>	5,3
Rørdiameter 48 mm	S 1500	G	<b>7016150</b>	7,7
	S 2000	G	<b>7016200</b>	10,1
	S 3000	G	<b>7016300</b>	15,2

**Splint til spireskjøt**

Diameter 16 mm

 For forsterkning av spireskjøt  
ved trekklast f eks ved hengende

stillas, løft eller stillas for værbeskyttelsestak



Låsesplint m/fjær 16

G

**2116000**

0,17

Låsesplint for offshore

G

**5141257**

0,3

**Horisontaler**

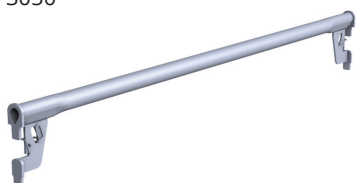

		Utfør.	Art. nr	Vekt
<b>Lengdebjelke</b>	1050	G	<b>7021102</b>	4,8
Med fjærlås	1250	G	<b>7021122</b>	6,5
Rørdiameter 34 mm	1655	G	<b>7021162</b>	6,7
Lengder fra 1050-4050	1964	G	<b>7021192</b>	8,0
	2500	G	<b>7021252</b>	10,9
	3050	G	<b>7021302</b>	12,3
	3650	G	<b>7021361</b>	22,6
	4050	G	<b>7021401</b>	24,8
<b>Enrørsbjelke</b>	564	G	<b>7022050</b>	3,1
Med fjærlås	700	G	<b>7022066</b>	3,3
Rørdiameter 48 mm	770	G	<b>7022073</b>	3,6
Lengder fra 564-3050	1050	G	<b>7022101</b>	4,4
	1250	G	<b>7022121</b>	5,1
	1655	G	<b>7022161</b>	6,3
	1964	G	<b>7022191</b>	7,3
	2500	G	<b>7022246</b>	8,9
	3050	G	<b>7022301</b>	11,3

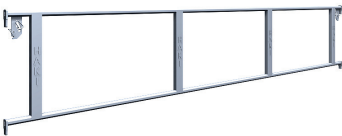
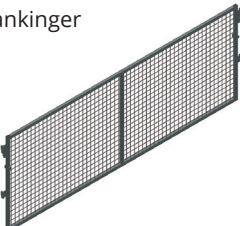

**Rekkverk**

		Utfør.	Art. nr	Vekt
<b>Rekkverksramme GFL</b>	564	G	<b>7052056</b>	3,8
Med fjærlås	700	G	<b>7052070</b>	3,8
Rør octagon 28 mm	770	G	<b>7052077</b>	4,0
	1050	G	<b>7052106</b>	4,9
	1250	G	<b>7052124</b>	5,7
	1655	G	<b>7052164</b>	7,4
	1964	G	<b>7052194</b>	8,1
	2357	G	<b>7052232</b>	8,9
	2500	G	<b>7052254</b>	9,2
	3050	G	<b>7052304</b>	10,5
				
<b>Rekkverksgrind med nett SGF</b>	1050	G	<b>7055101</b>	13,3
Trinnløst justerbart 118 mm i høyden for å	1250	G	<b>7055121</b>	14,6
kunne tilpasses ulike innplankinger	1655	G	<b>7055161</b>	17,0
Nøkkelvidde 22 mm	1964	G	<b>7055191</b>	19,4
	2500	G	<b>7055250</b>	23,2
	3050	G	<b>7055300</b>	26,8
				

**Stag**

		Utfør.	Art. nr	Vekt
<b>Diagonalstag DS</b>	1250	G	<b>7122124</b>	9,0
Med kilekoplinger. Rørdiameter 48 mm	1655	G	<b>7122164</b>	10,1
DS 1250 L=2004	1964	G	<b>7122194</b>	10,9
DS 1655 L=2285	2500	G	<b>7121254</b>	12,6
DS 1964 L=2523	3050	G	<b>7121304</b>	14,3
DS 2500 L=2967	3650	G	<b>7121364</b>	16,2
DS 3050 L=3450	4050	G	<b>7121404</b>	17,5
DS 3650 L=3988				
DS 4050 L=4357				
				
<b>Diagonalstag for trall/labanklemmer</b>	3050	G	<b>7121301</b>	15,5
Med kilekoplinger				
Rørdiameter 48 mm				
DS-UB 3050 L=3448				
				

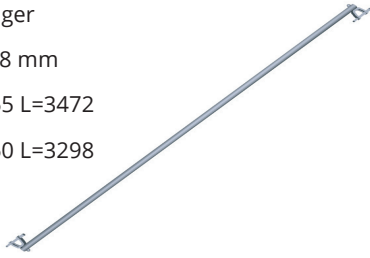

		Utfør.	Art. nr	Vekt
<b>Horisontaldiagonal HDS</b>	3050x1655	G	<b>7141000</b>	13,3
Med kilekoplinger	3050x1250	G	<b>7141001</b>	13,2
Rørdiameter 48 mm				
HDS 3050x1655 L=3472				
HDS 3050x1250 L=3298				



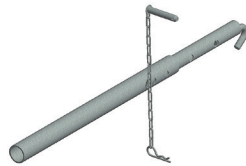
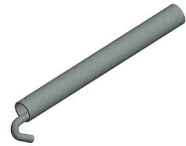

<b>Forankring</b>				
		Utfør.	Art. nr	Vekt
<b>Veggfestestag rør SVF</b>	450x48	G	<b>8832046</b>	2,2
Rørdiameter 48 mm	600x48	G	<b>8832061</b>	2,6
Krok diameter 16 mm	900x48	G	<b>8832091</b>	3,7
Tillatt belastning 9 kN	1200x48	G	<b>8832121</b>	4,8
Monteres med kopling fast 48x48				
<b>Veggfeste justerbart</b>		G	<b>8832110</b>	4,9
Justering 650 - 1100 mm				
Krok 16 mm				
Tillatt belastning 5,2 kN				
Monteres med kopling fast 48x48				
<b>Veggstag VST</b>	1000	G	<b>7111100</b>	5,3
Med leddet plate	2000	G	<b>7111200</b>	9,1
Rørdiameter 48 mm	3000	G	<b>7111300</b>	13,7
Monteres med kopling fast 48x48	4000	G	<b>7111400</b>	16,7
For tillatt belastning, se produktdatablad	5000	G	<b>7111500</b>	21,9
	6000	G	<b>7111600</b>	24,5

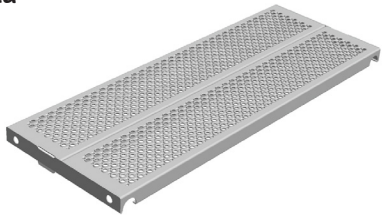

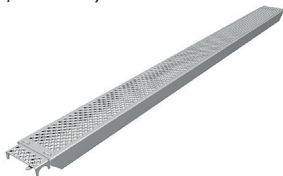
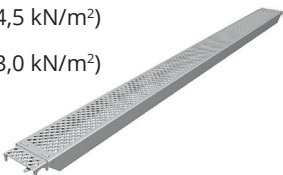
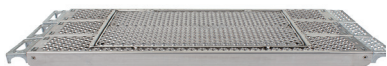



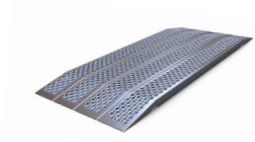

**Innplanking**

		Utfør.	Art. nr	Vekt
<b>Stillaslem Alu</b> 	1250x498x55	AL	<b>2021145</b>	7,8
	1250x398x55	AL	<b>2021146</b>	6,6
	1250x595x55	AL	<b>2021164</b>	8,4
<b>Komposittlem</b> Kan også leveres med kundens egen firmalogo 	1250x490		<b>2021406</b>	8,0
<b>Stige ST</b> Til Krokplan med luke 	2100	AL	<b>2091210</b>	3,4
<b>AL plank B=170 mm</b> L=564-2500 - Lastklasse 6 (6,0 kN/m <sup>2</sup> ) L=3050 - Lastklasse 5 (4,5 kN/m <sup>2</sup> ) 	564x170x90	AL	<b>2153056</b>	2,9
	770x170x90	AL	<b>2153081</b>	3,1
	1050x170x90	AL	<b>2153106</b>	4,3
	1250x170x90	AL	<b>2153126</b>	4,8
	1655x170x90	AL	<b>2153166</b>	6,0
	1964x170x90	AL	<b>2153196</b>	6,8
	2500x170x90	AL	<b>2153247</b>	8,3
	3050x170x90	AL	<b>2153306</b>	9,8
<b>AL plank B=230 mm</b> L=564-1964 - Lastklasse 6 (6,0 kN/m <sup>2</sup> ) L=2500 - Lastklasse 5 (4,5 kN/m <sup>2</sup> ) L=3050 - Lastklasse 4 (3,0 kN/m <sup>2</sup> ) 	564x230x90	AL	<b>2153055</b>	3,4
	770x230x90	AL	<b>2153080</b>	4,1
	1050x230x90	AL	<b>2153100</b>	4,9
	1250x230x90	AL	<b>2153120</b>	5,6
	1655x230x90	AL	<b>2153160</b>	6,9
	1964x230x90	AL	<b>2153190</b>	7,8
	2500x230x90	AL	<b>2153245</b>	9,5
	3050x230x90	AL	<b>2153300</b>	11,2
<b>Lukeplan AL B=690 mm</b> L=1250-1655 - Lastklasse 6 (6,0 kN/m <sup>2</sup> ) L=1964 - Lastklasse 4 (3,0 kN/m <sup>2</sup> ) L=2500-3050 - Lastklasse 3 (2,0 kN/m <sup>2</sup> ) 	1250x690	AL	<b>4098123</b>	19,9
	1655x690	AL	<b>4098163</b>	23,7
	1964x690	AL	<b>4098193</b>	26,6
	2500x690	AL	<b>4098253</b>	31,6
	3050x690	AL	<b>4098303</b>	36,7

**Innplanking**

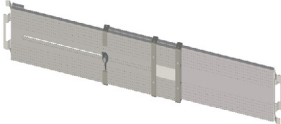
		Utfør.	Art. nr	Vekt
<b>Alu rampe</b>	 1400x500	AL	<b>2157004</b>	7,8
	1400x600	AL	<b>2157005</b>	10,3
<b>Hjørne dekkplater</b>	 564x564		<b>4011020</b>	4,5
	770x770		<b>4011021</b>	7,3
	1250x1250		<b>4011022</b>	14,5
<b>Krokplan B=600 mm</b>	 1250x600	AL	<b>4071128</b>	9,1
	1655x600	AL	<b>4071168</b>	11,1
	1964x600	AL	<b>4071198</b>	12,5

**Fotlister**

		Utfør.	Art. nr	Vekt
<b>Fotlist</b>	FL 3300x150x32		<b>2025331</b>	5,6
Tre, gul transparent	FL 3000x150x32		<b>2025300</b>	5,8
				
<b>Fotlist</b>	FL 1300x150x32		<b>2025133</b>	2,7
Fotlister med farge og logo iht kundespesifikasjon.	FL 3300x150x32		<b>2025333</b>	8,0
<b>Fotlist Aluminium</b>	700	AL	<b>4161071</b>	1,3
	770	AL	<b>4161077</b>	1,4
	1050	AL	<b>4161105</b>	1,9
	1250	AL	<b>4161121</b>	2,2
	1655	AL	<b>4161161</b>	2,9
	1964	AL	<b>4161191</b>	3,5
	2500	AL	<b>4161251</b>	4,6
	3050	AL	<b>4161301</b>	5,5
				
<b>Fotlist teleskopisk</b>	1200-1964	AL	<b>2026020</b>	5,0
	1900-3050	AL	<b>2026021</b>	7,3
				
<b>Fotlistbeslag</b>			<b>2131003</b>	0,1
Fjærstål				
<b>Fotlistbeslag</b>	LF 70		<b>7161006</b>	1,0
	LF 70 Kort		<b>7161012</b>	0,7
				
<b>Fotlistbeslag</b>	LFP 150x32		<b>2131001</b>	0,2
Plast				
<b>Låsejern for fotlist</b>			<b>1162002</b>	0,4
				



**Konsoller**

		Utfør.	Art. nr	Vekt
<b>Konsoll uten spireskjøt</b> Rørdiameter 48 mm Med fjærlås	     	G	<b>7211025</b>	1,6
		G	<b>7211033</b>	2,0
		G	<b>7211035</b>	2,0
		G	<b>7211041</b>	2,1
		G	<b>7211045</b>	2,3
		G	<b>7211061</b>	2,7
<b>Konsoll med spireskjøt</b> Rørdiameter 48 mm Med fjærlås	  	G	<b>7211051</b>	5,8
		G	<b>7211067</b>	5,9
		G	<b>7211071</b>	6,5
<b>Konsoll justerbar</b> Justerbar 460 - 690 mm Lastklasse 3 (2,0 kN/m <sup>2</sup> ) OBS! Kan ikke monteres i aluminiumsspir		G	<b>7211069</b>	4,1
<b>Konsolldiagonal</b> Kombineres med enrørsbjelke 1250 eller lengdebjelke 1250		G	<b>7212001</b>	11,1
<b>Hjørnekonsoll</b> Innvendig hjørnekonsoll - 2 plank Nøkkelvidde 22 mm		G	<b>7211046</b>	6,7

	Utfør.	Art. nr	Vekt
<b>Hjørnekonsoll</b>	G	<b>7211053</b>	18,0

Innvendig hjørnekonsoll - 3 plank  
Nøkkelvidde 22 mm

**Kombikonsoll KK**

700

G

**7211065**

9,3

For innplanking med RAM-plan





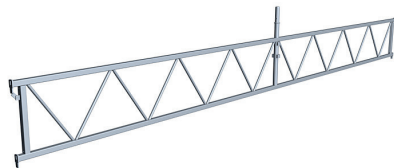

**Fagverk**

	Utfør.	Art. nr	Vekt
<b>Fagverksdrager</b>	G	<b>7031602</b>	59,1

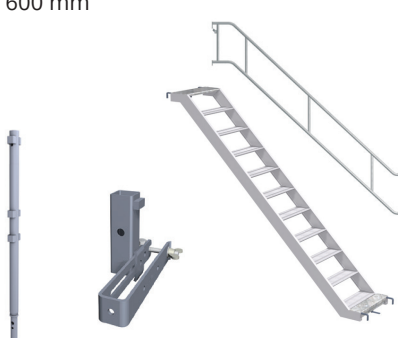
500/6100

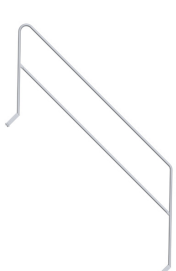

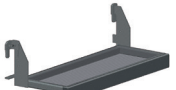









**Trapper & Stiger**

		Utfør.	Art. nr	Vekt
<b>UTV Trapp AL</b> Med hvilplan og låsing Bredder 600 mm 	UTV Gelender 2500x2000	AL	<b>4058245</b>	9,2
	UTV Gelender 3050x2000	AL	<b>4058300</b>	10,3
	UTV Gelender 3050x1500	AL	<b>4058150</b>	9,3
	UTV Trapp 2500x2000	AL	<b>4102247</b>	22,9
	UTV Trapp 3050x2000	AL	<b>4102302</b>	29,2
	UTV Trapp 3050x1500 med sklisikre trinn	AL	<b>2153039</b>	26,0
	UTV Trapp 3050x2000 med sklisikre trinn	AL	<b>2153040</b>	22,0
	Gelenderstolpe LSS 1000	G	<b>7015102</b>	4,2
	Feste LSS-UTV	G	<b>7058300</b>	1,5
	<b>UTV Trapp</b> Med hvilplan og låsing oppe LxH 3050x2000 mm Bredder 600 mm 	UTV Trapp 3050x2000	G	<b>2092200</b>
Gelender HL 3050x2000		G	<b>2161300</b>	19,3
Gelenderstolpe LSS 1000		G	<b>7015102</b>	4,2
Feste LSS-UTV		G	<b>8752001</b>	2,5
<b>UTV Gelender indre</b> Bredder 600 mm For trapp UTV AL og UTV galv. 	For UTV Trapp AL 3050x2000	G	<b>7058253</b>	11,4
	For UTV Trapp galv 3050x2000	G	<b>7058254</b>	11,5
	For UTV Trapp AL 2500x2000	G	<b>7058256</b>	10,4
<b>UTV Trapp AL</b> Med hvilplan og låsing oppe Bredder 600 mm 	UTV 500	AL	<b>4102055</b>	7,5
	UTV 1000	AL	<b>4102105</b>	11,2
	UTV 1500	AL	<b>4102155</b>	16,2
<b>Innstegstrapp</b> 	700/770	G	<b>7103065</b>	7,8



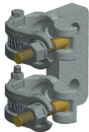



		Utfør.	Art. nr	Vekt
<b>STV Stige med hvilplan</b>		G	<b>7083202</b>	12,5
Med hvilplan og låsing oppe		G	<b>7083203</b>	17,1
LxH 1250x2000 mm alt.				
1655x2000 mm				
Bredde 475 mm				

## SS Opphengsbleslag







		Utfør.	Art. nr	Vekt
<b>SS Opphengsbleslag Gallerdørk</b>		G	<b>7171001</b>	2,4
Tillatt belastning 20,0 kN				
<b>SS Opphengsbleslag H-bjelke</b>		G	<b>7172100</b>	5,7
Tillatt belastning 20,0 kN		G	<b>7172000</b>	6,8
	80-180	G	<b>7172001</b>	7,6
	150-300			
	300-450			
<b>SS Opphengsbleslag L-bjelke</b>		G	<b>7176000</b>	5,3
Tillatt belastning 20,0 kN				
<b>SS Opphengsbleslag Bulb-Kjetting</b>		G	<b>7177002</b>	2,5
Tillatt belastning 20,0 kN		G	<b>7177001</b>	2,5
	160x9 - 200x12	G	<b>7177003</b>	3,7
	220x10 - 300x13			
	320x11 - 370x16			
<b>SS Opphengsbleslag Bulb-Kjetting</b>		G	<b>7177000</b>	1,6
For bulbplate 160x8 mm				
Tillatt belastning 12,0 kN				
Kan modifieres for andre størrelser på profilen				

		Utfør.	Art. nr	Vekt
<b>SS Opphengsbeslag Bulb-Rør</b> For bulbplate 160x8 mm Nøkkelvidde 22 mm Tillatt belastning 20,0 kN Kan modifieres for andre størrelser på profilen		G	<b>7177100</b>	3,0
<b>SS Opphengsbeslag kjetting</b> Tillatt belastning 20,0 kN		1362 850	G <b>7175001</b> G <b>7175002</b>	4,3 3,0
<b>SS Opphengsbeslag KF 48 dobbel</b> Hulldiameter 20 mm Nøkkelvidde 22 mm Tillatt belastning 20,0 kN			G <b>7175101</b>	2,1
<b>SS Klembeslag</b> Nøkkelvidde 30 mm		500	G <b>7215032</b>	5,5
<b>SS Monteringsverktøy til hengende plattform</b>			G <b>7500032</b>	13,0
<b>Stillaskjetting med to sjakler</b>		2 m 4 m	G <b>7175005</b> G <b>7175006</b>	4,7 8,9







**Andre komponenter**

			Utfør.	Art. nr	Vekt
<b>Bunnskrue leddet 750</b>			G	<b>2071005</b>	5,9
<b>Bunnskrue leddet</b>		BSLL 200	G	<b>7153005</b>	12,0
<b>Bunnspiss</b>		BPS	G	<b>7151002</b>	9,0
<b>Låsefjær til bunnskrue</b> Holder bunnskrue på plass ved løft av stillasseksjonen			G	<b>2071100</b>	0,2
<b>Toppspire SC</b>		SC 353 SC 853 SC 1353 SC 1853	G G G G	<b>7011004</b> <b>7011104</b> <b>7011154</b> <b>7011204</b>	2,0 4,8 7,3 9,8
<b>Høydeinnstillingsspire</b>			G	<b>7202001</b>	6,5
<b>Enkelbjelke</b>		300 350	G G	<b>7022030</b> <b>7022035</b>	1,5 1,7

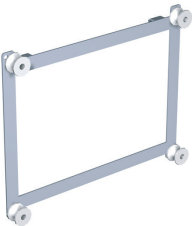
		Utfør.	Art. nr	Vekt
<b>Spireholder</b> For rørdiameter 50 mm Kan låses med låsesplint 12 mm	50	G	<b>7208025</b>	2,3
				
<b>Spireholder</b> For rørdiameter 34 mm Med låseskrue	S	G	<b>7208018</b>	3,9
				
<b>Bjelkerytter</b> For rørdiameter 50 mm Kan låses med låsesplint 12 mm	50	G	<b>7208024</b>	1,2
				
<b>BRS Bjelkerytter</b> For rørdiameter 34 mm Med låseskrue	Bøyer på samme nivå Bøyer på høyt nivå Bøyer på lavt nivå	G G G	<b>7208020</b> <b>7208021</b> <b>7208022</b>	2,0 2,4 2,5
				
<b>Bjelkerytter dobbel</b>	21 22	G G	<b>7208033</b> <b>7208031</b>	2,4 2,4
				
<b>Løs Bøylegruppe</b> Nøkkelvidde 22 mm For rekkverk ved f. eks. hjørneløsninger		G	<b>8792000</b>	0,6
				
<b>Låseklammer rekkverk</b> Nøkkelvidde 22 mm For rekkverk, rørdiameter 38 mm		G	<b>8833000</b>	0,8
				



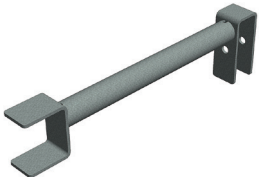
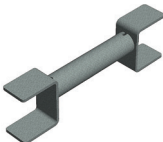



		Utfør.	Art. nr	Vekt
<b>Rekkverksstolpe SRS</b> Til montasje på lengdebjelke		1000	G <b>7015001</b>	7,3
<b>Mellomspire</b> Til montasje på lengdebjelke		2000	G <b>7015008</b>	12,5
<b>Rekkverksstolpe</b> Nøkkelvidde 22 mm Til montasje på enrørsbjelke		22	G <b>7015006</b>	6,1
<b>Sikkerhetsbøyle</b> Til montasje på lengdebjelke			G <b>7053110</b>	5,5
<b>Dekkplate AL</b> AL-dørkplate Med håndtak og hull for surring, til tetting av hull i innplanking		995x495x4 695x495x4 495x495x4 295x295x4 395x395x4 695x695x4 695x695x4 1195x595x4	AL <b>4011000</b> AL <b>4011001</b> AL <b>4011002</b> AL <b>4011006</b> AL <b>4011007</b> AL <b>4011008</b> AL <b>4011009</b> AL <b>4011010</b>	5,2 3,6 2,5 0,3 0,7 0,8 1,9 2,8
<b>Dekkplate stål</b>		190 x 1055 315 x 1055 450 x 1062	G <b>2153020</b> G <b>2153015</b> G <b>2153010</b>	3,4 5,5 7,5
<b>Utfyllingsplater AL</b>		1245 x 227 1645 x 227 1945 x 227 2545 x 227 3045 x 227	AL <b>2750411</b> AL <b>2750412</b> AL <b>2750414</b> AL <b>2750413</b> AL <b>2750415</b>	2,2 2,9 3,4 4,4 5,3



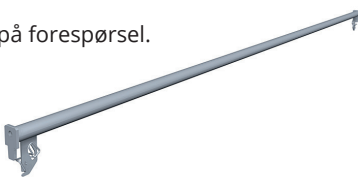





		Utfør.	Art. nr	Vekt
<b>Beslag skyvbar grind</b>		G	<b>7053001</b>	9,4
Beslaget monteres på rekkverksgrind og kan lage skyvbar port i faket ved siden av				
<b>Stillastak</b>		G	<b>7214066</b>	9,5
				
<b>Tverrbjelkebeslag</b>		TBJ	<b>7201000</b>	1,0
				
<b>Kombinasjonsbeslag</b>		KJS	<b>7205010</b>	2,7
				
<b>Plankerytter</b>		460-2 bd	<b>7218023</b>	4,0
				
<b>Plankerytter</b>		230-1 bd	<b>7218032</b>	3,0
		460-2 bd	<b>7218033</b>	3,5
				
<b>Stillashjul</b>		LRG Wicke S4	<b>2012005</b>	7,4
Ø38 mm Hjuldiameter 250 mm Justerbar 330-630 mm Tillatt belastning 10,0 kN, rullende 4,0 kN				



			Utfør.	Art. nr	Vekt
<b>Støtteben</b> Justerbar		STB 1000	AL	<b>4143101</b>	8,6
<b>Toppgaffler</b> BV 10 till omvendt bunnskrue og toppspire, BVV 175 til spire S		BV 10 BVV 175	G G	<b>7155000</b> <b>7155131</b>	3,0 3,5
<b>Tripod</b> Med bøylor på ett spir Rørdiameter 48 mm	 	500 1000 1500 2000 3000	G G G G G	<b>7203340</b> <b>7203341</b> <b>7203344</b> <b>7203342</b> <b>7203343</b>	10,0 17,3 23,3 31,8 45,8
<b>Justerbar Bunnskrue 60</b>			G	<b>2071061</b>	15,6
<b>Adaptor Tripod</b>	 	60 48	G G	<b>7203312</b> <b>7203311</b>	11,6 10,0
<b>Topplate Tripod</b>	 	Toppgaffel BVV tripod Topplatta Tripod	G G	<b>7155100</b> <b>7203309</b>	3,0 6,3
<b>Adapter</b> Brukes som innlegg i Ø48 kopling for å kunne festes på Ø34 rør		35		<b>2041001</b>	0,03
<b>Låsesplint</b> Diameter 12 mm		12		<b>2113100</b>	0,1
<b>Låsesplint for offshore med kjetting</b>		16	G	<b>5141257</b>	0,3
<b>Låsesplint m/fjær</b>		16	G	<b>2116000</b>	0,2

**Øvrige komponenter**



		Utfør.	Art. nr	Vekt
<b>Enkeltbjelke</b> Andre lengder på forespørsel.	3050	G	<b>8722300</b>	10,5
				
<b>Monteringsverktøy for rekkverk</b>		AL	<b>4052001</b>	1,4
				
<b>Kombinasjonsbeslag</b>		G	<b>7205010</b>	2,2
				
<b>Stillasbukk</b> Med teleskopisk forlengelsesrør To stillasbukker kombineres med en bjelke til en bukk	SBT	G	<b>7013010</b>	9,2
				
<b>Hakitainer</b> OBS! Ikke godkjent som løfteredskap. Gods skal stropes til Hakitaineren ved løfting med kran	1100 1500	G G	<b>7181110</b> <b>7181150</b>	33,6 39,4
				
<b>HAKI Galge</b> HAKI Galgen kombineres med linhjul eller HAKI sikkerhetsblokk. Kan også brukes til vinsj. Kopling med bøyle brukes ved montering på for eksempel stillasrør 48 mm. Tillat last HAKI Galge 200 kg, Linhjul 70 kg	Hjul til galge Kopling m/bøyle Galge, HAKI		<b>5211000</b> <b>7164001</b> <b>7173002</b>	3,6 0,9 7,9
				

	Utfør.	Art. nr	Vekt
<b>HAKI Offshore galge</b> Ferdig sertifisert, komplett med Sikkerhetsblokk og 30 m stillastau med kause og krok. Tillatt last 50 kg.		<b>7173003</b>	25,0
<b>HAKI Sikkerhetsblokk</b> Tillatt last 50 kg		Rep Ø 18 mm Sikkerhetsblok Sikkerhetsblokk, HAKI	<b>2600290</b> 10,0 <b>26150AF</b> 4,5
<b>Stillastau</b>		30m m/kause og krok 60m m/kause og krok 100m m/kause og krok	<b>2610030</b> 12,1 <b>2610060</b> 22,1 <b>2610100</b> 35,1
<b>Stillasskilt</b> For å henge opp på stillas Skiltholder og skilt		Skiltholder Skilt	<b>10028</b> 0,1 <b>10036</b> 0,04
<b>Øyeskrue</b> Øyebolt med godstykkelse 10mm og øyediameter 20 mm. Stålkvalitet 8.8. Elzink. 100 stk pr pakke		Øyeskrue L=100	<b>6130052</b> 0,1
<b>Testnøkkel til forankring 350Nm</b>			<b>2051052</b> 2,5
<b>Monteringsverktøy låsefjær</b>		Skrallenøkkel 21/22mm Skrallenøkkel 22/23mm	<b>1051001</b> 0,5 <b>2051022</b> 0,5 <b>2051023</b> 0,5
<b>Låsefjær</b>			<b>6130000</b> 0,04

**Spirer**

		Utfør.	Art. nr	Vekt
<b>Spire S4 AL</b>		AL	<b>4017056</b>	1,6
Spireskjøt med tapp Ø 38 mm		AL	<b>4017106</b>	2,8
Rørdiameter 48 mm		AL	<b>4017156</b>	4,0
		AL	<b>4017206</b>	5,2
		AL	<b>4017306</b>	7,7
<b>Splint til spireskjøt</b>		Fzb	<b>2116000</b>	0,17
Diameter 16 mm		G	<b>5141257</b>	0,3
For forsterkning av spireskjøt ved trekklast f eks ved hengende stillas, løft eller stillase for værbeskyttelsestak				
<b>Toppire S4 AL</b>		AL	<b>4011105</b>	1,0
		AL	<b>4011104</b>	2,2
		AL	<b>4011106</b>	3,4
		AL	<b>4011107</b>	4,6
		AL	<b>4011304</b>	7,7

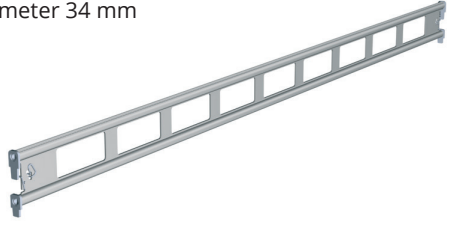

**Horisontaler**

		Utfør.	Art. nr	Vekt
<b>Lengdebjelke</b>		AL	<b>4021031</b>	1,9
Med fjærlås		AL	<b>4021073</b>	2,9
Rørdiameter 34 mm		AL	<b>4021101</b>	3,5
		AL	<b>4021121</b>	4,2
		AL	<b>4021161</b>	4,8
		AL	<b>4021191</b>	5,8
		AL	<b>4021246</b>	7,2
		AL	<b>4021301</b>	8,5
<b>Enrørsbjelke</b>		AL	<b>4022051</b>	2,5
Med fjærlås		AL	<b>4022066</b>	2,7
Rørdiameter 48 mm		AL	<b>4022073</b>	2,9
		AL	<b>4022101</b>	3,2
		AL	<b>4022121</b>	3,6
		AL	<b>4022161</b>	4,1
		AL	<b>4022191</b>	4,5
		AL	<b>4022246</b>	5,4
		AL	<b>4022301</b>	6,2

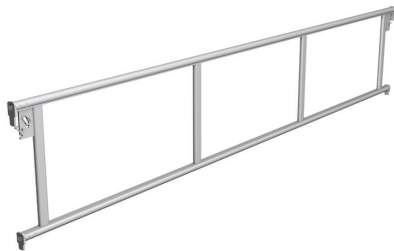
**Rekkverk**

		Utfør.	Art. nr	Vekt
<b>Rekkverksramme</b>	700	AL	<b>4052066</b>	3,3
Med fjærlås	770	AL	<b>4052073</b>	3,5
	1050	AL	<b>4052101</b>	4,5
	1250	AL	<b>4052121</b>	4,8
	1655	AL	<b>4052161</b>	5,9
	1964	AL	<b>4052191</b>	6,6
	2500	AL	<b>4052246</b>	7,8
	3050	AL	<b>4052301</b>	8,9

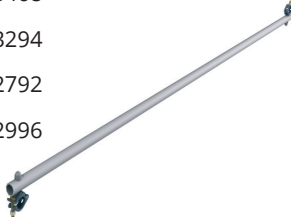
**Stag**

		Utfør.	Art. nr	Vekt
<b>Diagonalstag</b>	1250	AL	<b>4122120</b>	4,5
Rørdiameter 48 mm	1655	AL	<b>4122160</b>	4,9
	1964	AL	<b>4122190</b>	5,4
	2500	AL	<b>4122245</b>	6,1
	3050	AL	<b>4122300</b>	6,7
	<b>Horisontaldiagonal HDS</b>	3050x1655	AL	<b>4141000</b>
Rørdiameter 48 mm	3050x1250	AL	<b>4141001</b>	6,5
HDS 3050x1655 AL L=3468	2500x1250	AL	<b>4141005</b>	6,0
HDS 3050x1250 AL L=3294	2500x1655	AL	<b>4141006</b>	6,3
HDS 2500x1250 AL L=2792				
HDS 2500x1655 AL L=2996				
				
<b>Horisontaldiagonal teleskopisk HDS</b>		AL	<b>4141010</b>	6,3
Rørdiameter 38-48 mm				
L=1960-3470 mm				
For fakkstørrelser fra 1655x1050 mm				
til 3050x1655 mm med 16				
faste posisjoner				

**Konsoller**

		Utfør.	Art. nr	Vekt
<b>Konsoll</b>	SK 230	AL	<b>4211024</b>	1,7
Uten spireskjøt	SK 460	AL	<b>4211047</b>	1,9
Med fjærlås				
<b>Konsoll</b>	SK 564	AL	<b>4211052</b>	3,6
Med spirekjøt	SK 700	AL	<b>4211069</b>	3,8
Med fjærlås	SK 770	AL	<b>4211074</b>	3,9
				

		Utfør.	Art. nr	Vekt
Konsolldiagonal	150-5 Bd	AL	<b>4212002</b>	7,8



### Andre komponenter

		Utfør.	Art. nr	Vekt
Spireholder S4 AL		AL	<b>4208002</b>	1,7



### Bjelkerytter

BR 34

 AL **4208020** 1,1

### Låselister

 700x100  
 770x100  
 1050x100  
 1250x100  
 1655x100  
 1964x100  
 2500x100  
 3050x100

 AL **4024070** 1,1  
 AL **4024077** 1,3  
 AL **4024105** 1,9  
 AL **4024125** 2,3  
 AL **4024165** 3,1  
 AL **4024190** 3,7  
 AL **4024250** 4,8  
 AL **4024300** 6,0

### Låseplate

 AL **6230800** 0,7

**Bunnskrue**

		Utfør.	Art. nr	Vekt
<b>Bunnskrue for S6 spirer</b>	BS S6-760/515	G	<b>2071032</b>	6,2
Stål				
Ø 34 mm				
Justerbar 55-570 mm				

**Spirer**

		Utfør.	Art. nr	Vekt
<b>Spire S6 AL med splint</b>	S6 500	AL	<b>4018050</b>	2,2
Spireskjøt med tapp Ø 34 mm	S6 1000	AL	<b>4018100</b>	3,7
Rørdiameter Ø 48 mm	S6 1500	AL	<b>4018150</b>	5,3
Med montert splint	S6 2000	AL	<b>4018200</b>	6,8
	S6 3000	AL	<b>4018300</b>	9,9

**Toppspire S6 AL**

S6 SC 353	AL	<b>4018053</b>	1,2
S6 SC 853	AL	<b>4018103</b>	2,8
S6 SC 1353	AL	<b>4018153</b>	4,3
S6 SC 1853	AL	<b>4018253</b>	5,8









**Konsoller**

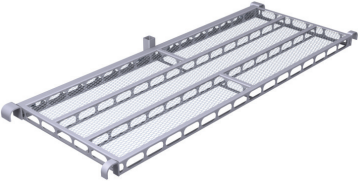

		Utfør.	Art. nr	Vekt
<b>Konsoll med spireskjøt S6 AL</b> Med spireskjøt Ø 34 mm Rørdiameter 48 mm Med fjærlås	SK S6-564	AL	<b>4211053</b>	3,9
	 SK S6-770	AL	<b>4211075</b>	4,2
<b>Konsolldiagonal S6 AL</b> Med spireskjøt Ø 34 mm Rørdiameter 48 mm Med fjærlås Kombineres med enrørsbjelke 1250 eller lengdebjelke 1250	SKD S6-1250	AL	<b>4212001</b>	7,6

**Andre komponenter**



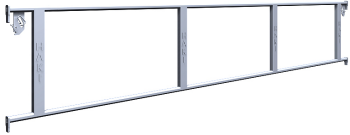
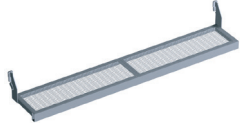

		Utfør.	Art. nr	Vekt
<b>Stillashjul S6</b> Ø 34 mm Hjul diameter 250 mm Justerbar 330-630 mm Tillatt belastning 10,0 kN, rullende 4,0 kN	 LRG Wicke S6		<b>2012006</b>	7,1
<b>Spireholder S6 AL</b> Med spireskjøt Ø 34 mm För rørdiameter 34 mm Kan låses med låsesplint 12 mm	 S6	AL	<b>4208001</b>	1,8

**Trappetårn 3050x1655 Symmetrisk**

		Utfør.	Art. nr	Vekt
<b>STS Hvilplan</b>		G	<b>7095001</b>	19,2
<b>STS Trappeløp</b>		1000 1500 2000	G <b>7101101</b> G <b>7101151</b> G <b>7101201</b>	38,5 28,6 33,9
<b>STS Gelenderstolpe</b> Stolpen låses med låsekrok LK 8793000			G <b>7015102</b>	4,2
<b>Rekkverksstolpe</b> Nøkkelvidde 22 mm For montasje på enrørsbjelke		22	G <b>7015006</b>	6,1
<b>STS Gelender</b>		1000 1500 2000	G <b>7058103</b> G <b>7058153</b> G <b>7058203</b>	7,0 7,5 8,4
<b>STS Rekkverksgrind</b>		SGTS	G <b>7053002</b>	10,9
<b>STS Fotlist</b>		873 1655	G <b>2025085</b> G <b>2025159</b>	3,1 4,5





		Utfør.	Art. nr	Vekt
<b>STS Rekkverksramme Trappetårn</b>	SGS	G	<b>7053003</b>	7,6
				
<b>STS Rekkverksramme</b>	GFL 2357	G	<b>7052232</b>	8,9
				
<b>STS Innstegstrapp</b>	1655	G	<b>7103160</b>	14,7
				
<b>STS Låsekrok</b>	LK 10x48	G	<b>8793000</b>	0,1
				

**Trappetårn 3050x1655 Tradisjonelt**



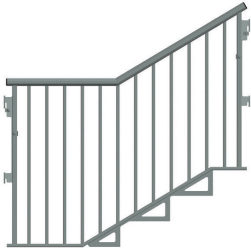

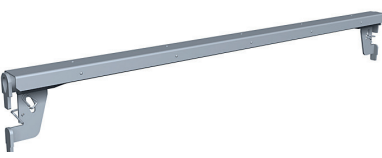
		Utfør.	Art. nr	Vekt
<b>Hvilplan VLP</b>		G	<b>7095000</b>	26,6
				
<b>Trappeløp TRP</b>	1000	G	<b>7101100</b>	43,6
	1500	G	<b>7101150</b>	28,3
	2000	G	<b>7101200</b>	35,0
				
<b>SGT Rekkverksramme Trappetårn</b>		G	<b>7053000</b>	7,6
				
<b>STS Gelenderstolpe</b>		G	<b>7015102</b>	4,2
				

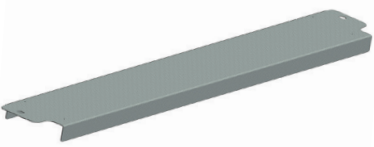
**Offentlig Trappetårn**





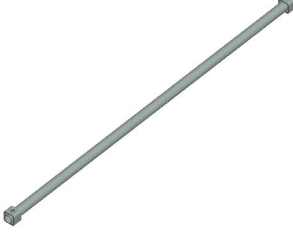
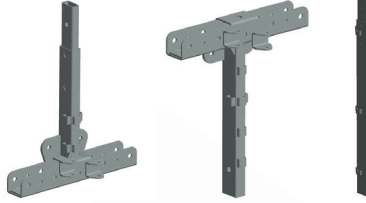

			Utfør.	Art. nr	Vekt
STC Innstegsbjelke		1250	G	<b>7104120</b>	5,3
STC Innstegstrapp		1250	G	<b>7103120</b>	11,1
STC Fotlist		1250		<b>2025119</b>	3,5
STC Gelender øvre			G	<b>7058252</b>	6,9
STC Gelender komplett			G	<b>7058261</b>	8,6
PAS Trappevange		1655x1000	G	<b>7102100</b>	25,0
		2500x1500	G	<b>7102150</b>	34,5
PAS Gelender		1655x1000	G	<b>7058100</b>	26,5
		2500x1500	G	<b>7058152</b>	36,5

		Utfør.	Art. nr	Vekt
<b>PAS Gelender</b>	1655x500	G	<b>7058050</b>	24,0
				
<b>PAS Rekkverk</b>	300	G	<b>7053030</b>	7,5
	564	G	<b>7053056</b>	12,1
	700	G	<b>7053070</b>	11,9
	770	G	<b>7053077</b>	12,5
	1050	G	<b>7053105</b>	15,7
	1250	G	<b>7053125</b>	19,5
	1655	G	<b>7053165</b>	23,0
	1964	G	<b>7053191</b>	28,2
	2500	G	<b>7053250</b>	34,2
<b>PAS Enrørsbjelke m dekkplate</b>	1250	G	<b>7104125</b>	6,7
	1655	G	<b>7104166</b>	8,5
	1964	G	<b>7104191</b>	10,0
<b>PAS Gelender innsteg</b>	3-trinns	G	<b>7058004</b>	15,0
<b>PAS Trappevange</b>	3-trinns	G	<b>7102006</b>	10,7
				
<b>PAS Diagonal</b>	1655	G	<b>7125166</b>	8,1
	2500	G	<b>7125251</b>	11,5
<b>PAS/HBS Tåreplateplank Toppsteg</b>	1655x250	G	<b>2140162</b>	17,3
				

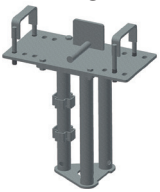
**HBS Heavy Bridge System**

		Utfør.	Art. nr	Vekt
<b>HBS Enrørsbjelke med skrulås SBF</b> 	1250	G	<b>7104124</b>	5,3
	1655	G	<b>7104164</b>	6,6
	1964	G	<b>7104194</b>	7,5
	2500	G	<b>7104254</b>	9,1
<b>HBS Tåreplateplank</b> 	1250x200	G	<b>2140125</b>	13,1
	1250x250	G	<b>2140126</b>	14,9
	2500x200	G	<b>2140255</b>	26,2
	2500x250	G	<b>2140256</b>	29,8
<b>HBS Horisontalstag</b> 	1250x1250	G	<b>7105121</b>	4,4
	2500x1250	G	<b>7105126</b>	8,1
	1250x1655	G	<b>7105161</b>	5,0
	1250x1964	G	<b>7105191</b>	5,7
	2500x1655	G	<b>7105195</b>	7,4
	2500x1964	G	<b>7105197</b>	7,7
	2500x2500	G	<b>7105199</b>	8,7
	1250x2500	G	<b>7105251</b>	6,8
<b>HBS Pilar</b> 	Underdel	G	<b>7104108</b>	23,6
	Overdel	G	<b>7104109</b>	21,5
	Mellomdel	G	<b>7104140</b>	16,0
<b>HBS Sidestag</b> 	4000	G	<b>7104141</b>	16,3
<b>HBS Diagonalstag</b> 	1250	G	<b>7104138</b>	14,8
	2500	G	<b>7104119</b>	17,0

			Utfør.	Art. nr	Vekt
HBS Øvre Bjelke		1250	G	<b>7104135</b>	10,9
		2500	G	<b>7104118</b>	23,2
HBS Nedre Bjelke		1250	G	<b>7104136</b>	12,5
		2500	G	<b>7104130</b>	26,8
HBS Kledningspanel		250x1250		<b>2033120</b>	2,0
		250x2500		<b>2033250</b>	4,0
HBS U-Profil Kledningsprofil		Venstre	G	<b>7104129</b>	3,5
		Høyre	G	<b>7104131</b>	3,5
HBS H-Profil kledningsprofil			G	<b>7104132</b>	7,0
HBS Låsklamme Kledningsprofil			G	<b>7104133</b>	0,5

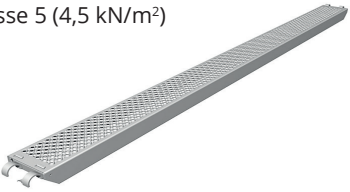
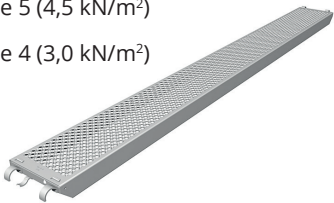
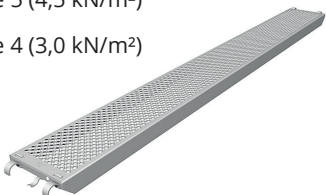

		Utfør.	Art. nr	Vekt
<b>HBS Tripod Topadapter inkl. klembeslag</b>		G	<b>7104111</b>	27,5
<b>HBS Splint</b>			<b>2113010</b>	0,3
		G	<b>6130296</b>	0,02
		Fzb	<b>6130203</b>	0,02
	20 L=90		<b>2113011</b>	0,2
		G	<b>6130216</b>	0,01
		Fzb	<b>6130203</b>	0,02
	20 L=70		<b>2113012</b>	0,2
		G	<b>6130296</b>	0,02
		Fzb	<b>6130203</b>	0,02

**PAS/HBS Innplanking**



		Utfør.	Art. nr	Vekt
<b>AL plank B=200 mm</b>		AL	<b>2153079</b>	3,6
Med lås i hver ende		AL	<b>2153105</b>	4,5
L=770-2500 - Lastklasse 6 (6,0 kN/m <sup>2</sup> )		AL	<b>2153125</b>	5,0
L=3050 - Lastklasse 5 (4,5 kN/m <sup>2</sup> )		AL	<b>2153165</b>	6,2
		AL	<b>2153195</b>	7,1
		AL	<b>2153255</b>	8,7
		AL	<b>2153305</b>	10,3
<b>AL plank B=295 mm</b>		AL	<b>2153078</b>	4,4
Med lås i hver ende		AL	<b>2153104</b>	5,4
L=770-1964 - Lastklasse 6 (6,0 kN/m <sup>2</sup> )		AL	<b>2153124</b>	6,1
L=2500 - Lastklasse 5 (4,5 kN/m <sup>2</sup> )		AL	<b>2153164</b>	7,5
L=3050 - Lastklasse 4 (3,0 kN/m <sup>2</sup> )		AL	<b>2153194</b>	8,6
		AL	<b>2153254</b>	10,5
		AL	<b>2153304</b>	12,4
<b>AL plank B=320 mm</b>		AL	<b>2153077</b>	4,7
L=1250-1964 - Lastklasse 6 (6,0 kN/m <sup>2</sup> )		AL	<b>2153103</b>	5,7
L=2500 - Lastklasse 5 (4,5 kN/m <sup>2</sup> )		AL	<b>2153123</b>	6,4
L=3050 - Lastklasse 4 (3,0 kN/m <sup>2</sup> )		AL	<b>2153163</b>	7,9
		AL	<b>2153193</b>	9,1
		AL	<b>2153253</b>	11,0
		AL	<b>2153303</b>	13,1

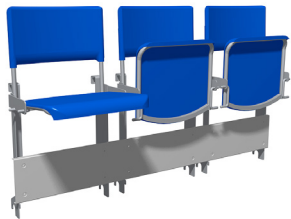

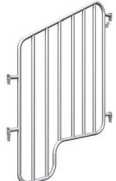
**Tribune**

		Utfør.	Art. nr	Vekt
<b>Stolseksjon</b> 	Stolseksjon tribune 1		<b>2022111</b>	9,7
	Stolseksjon tribune 2		<b>2022112</b>	19,5
	Stolseksjon tribune 3		<b>2022113</b>	29,0
	Stag stolseksjon 1050	G	<b>7104100</b>	4,5
	Låsing stolseksjon	G	<b>7161510</b>	0,9
<b>Tribunekonsoll</b> Bærer Alu-planken på ståplass og i trapp 		G	<b>7211002</b>	3,4
<b>Sparkebord</b> Benyttes som sikring i trapp 	1655	G	<b>2028160</b>	9,2
<b>Rekkverksgrind</b> Håndlist og grind tilpasset trapp 	1050	G	<b>7053100</b>	15,2

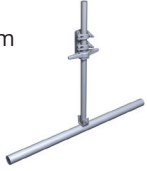

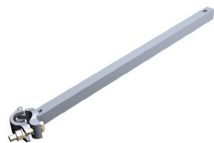

**Skiltstillas**

		Utfør.	Art. nr	Vekt
<b>Motvekt</b> 	Motvekt betong 1500 kg		<b>2121000</b>	1500
	Skive SRB 21x36x3	G	<b>6130296</b>	0,02
	Skrue M20x140	G	<b>6130350</b>	0,4
	Firkantrør 50x50-650	G	<b>7156000</b>	4,2
<b>Bunnskrue</b> Leddet bunnrør L=1200 mm Ø 60 mm Justerbar 176-711 mm Nøkkelvidde 22 mm 	BSLL 1200	G	<b>7153007</b>	19,4
<b>Bøylegruppe løs</b> 4x60° 	4x60	G	<b>7206000</b>	2,6
<b>Kopling fast</b> Vinklet 30° Nøkkelvidde 22 mm 	KF 34x48 30	G	<b>7164000</b>	1,1

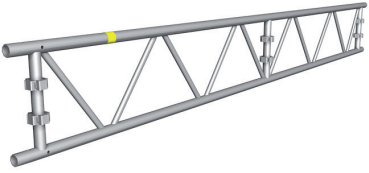
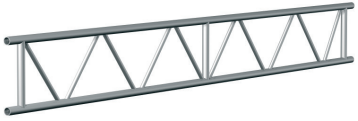

	Utfør.	Art. nr	Vekt
<b>Belysningskonsoll</b> Nøkkelvidde 22 mm	G	<b>7213000</b>	1,8

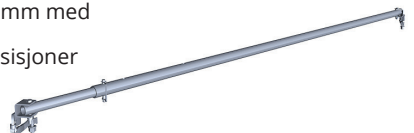

**450 Komponenter**

		Utfør.	Art. nr	Vekt
<b>450 Fagverksdrager m/bøyer</b>	2220	AL	<b>4032211</b>	9,9
Med bøyer vertikalt og hull i øverste rør for skinnefeste.	4100	AL	<b>4032411</b>	17,8
Dragerne skjøtes med 2 stk rette skjøterør 7203000 og	6100	AL	<b>4032611</b>	25,8
8 stk 12mm splinter pr skjøt	8100	AL	<b>4032811</b>	34,0
				
<b>450 Fagverksdrager</b>	4100	AL	<b>4032410</b>	16,7
Fagverksdrager skjøtes med 2 stk. rette skjøterør	6100	AL	<b>4032610</b>	24,3
7203000 og 8 stk 12mm splinter	8100	AL	<b>4032810</b>	32,2
				
<b>450 Skjøterør</b>	Skjøterør 22,5 nedre	G	<b>7201316</b>	2,6
Skjøterørene skal monteres med	Skjøterør rett	G	<b>7203000</b>	2,0
4 st låsesplinter 12 mm pr skjøterør	Skjøterør 30 nedre	G	<b>7203003</b>	2,8
	Skjøterør 30 øvre	G	<b>7203004</b>	5,7
	Skjøterør 15 nedre	G	<b>7203005</b>	2,3
	Skjøterør 15 øvre	G	<b>7203008</b>	4,0
	Skjøterør 22,5 øvre	G	<b>7203013</b>	4,2
				
<b>450 Skjøterør takfot</b>	Skjøterør takfot 15 inre	G	<b>7201313</b>	2,6
Skjøterørene skal monteres med	Skjøterør takfot 22,5 inre	G	<b>7201315</b>	2,9
låsesplint 12 mm	Skjøterør takfot 15 yttre	G	<b>7203012</b>	5,1
	Skjøterør takfot 22,5 yttre	G	<b>7203014</b>	3,9
				
<b>450 Endestykke til Fagverksdager</b>		G	<b>7203338</b>	5,8
				
<b>450 Diagonalstag teleskopisk</b>		AL	<b>4141020</b>	8,1
Med bøyrefester				
For fagverksdrager 450 AL med bøyer				
For fagstorlekar 3050x1960 mm,				
3050x1920 mm samt				
3050x1880 mm med				
tre faste posisjoner				
				

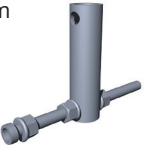









		Utfør.	Art. nr	Vekt
<p><b>Enkeltbjelke</b></p> <p>Andre lengder på forespørsel</p> <p>Med fjærlås</p> <p>Rørdiameter 42 mm</p>		LBE 3050	G <b>8722300</b>	10,5
<p><b>Takfotsbeslag</b></p>			G <b>7014000</b>	3,8
<p><b>Forsterkningsdetalj</b></p>			G <b>7142000</b>	10,1
<p><b>Hjul for tak</b></p>			G <b>7142001</b>	14,5
<p><b>Låsebeslag for hjul</b></p>			G <b>7165002</b>	5,3
<p><b>450 Opphengsbeslag LB</b></p> <p>Nøkkelvidde 22 mm</p> <p>For montering av fagverksdrager 450 AL som rullebane for tak</p> <p>Monteres på doble lengdebjelker</p>			G <b>7175003</b>	5,6
<p><b>450 Veggstolpe</b></p>			G <b>7014010</b>	12,7

		Utfør.	Art. nr	Vekt
<b>450 Skinne</b>	2000	AL	<b>7541200</b>	4,2
L=2000 og 3360 mm	3360	AL	<b>7541336</b>	7,2
Med 7540001 Skjøtepinne AL montert i øvre enden Merket med art. nr i øvre enden				
<b>450 Skinne takfot</b>		Fzb	<b>7541004</b>	1,0
Monteres med 1 stk låsesplint 12 mm				
<b>450 Mønerulle</b>	3050	G	<b>7500030</b>	15,5
				



**Bunnkomponenter**

		Utfør.	Art. nr	Vekt
<b>Bunnskruer</b> Justerbar 55-570 mm		G	<b>2071000</b>	5,0

**Rammer**

			Utfør.	Art. nr	Vekt
<b>Ramme 2000</b>		RA 2000	G	<b>8731204</b>	17,1
<b>Ramme 2000 AL</b>		RA 2000	AL	<b>4731201</b>	8,9
<b>Ramme 1000</b>		RA 1000	G	<b>8731104</b>	12,4
<b>Ramme 1000 AL</b>		RA 1000	AL	<b>4731101</b>	6,4
<b>Ramme 800</b>		RA 800	G	<b>8731084</b>	10,0
<b>Ramme 800 AL</b>		RA 800	AL	<b>4731081</b>	5,1
<b>Ramme 500</b>		RA 500	G	<b>8731053</b>	7,0
<b>Ramme 500 AL</b>		RA 500	AL	<b>4731051</b>	3,8
<b>Ramme med fotlist</b>		RAF 1000	G	<b>8731105</b>	14,5
<b>Ramme med fotlist</b>		RAF 1000	AL	<b>4731105</b>	7,7
<b>L-ramme</b>		RAL 1000	G	<b>8734100</b>	6,1
		RAL 2000	G	<b>8734200</b>	9,8

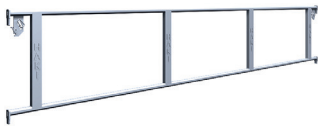
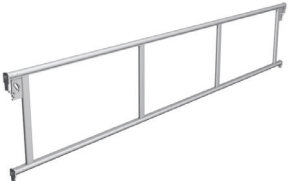

**Rekkverk**

			Utfør.	Art. nr	Vekt
<b>Rekkverksramme GFL</b>		700	G	<b>7052070</b>	3,8
Med fjærlås		1250	G	<b>7052124</b>	5,7
Rør octagon 28 mm		1655	G	<b>7052164</b>	7,4
		1964	G	<b>7052194</b>	8,1
		2500	G	<b>7052254</b>	9,2
		3050	G	<b>7052304</b>	10,5
<b>Rekkverksramme AL</b>			SKRD 700	AL	<b>4052066</b>
Med fjærlås		SKRD1250	AL	<b>4052121</b>	4,8
		SKRD 1655	AL	<b>4052161</b>	5,9
		SKRD 1964	AL	<b>4052191</b>	6,6
		SKRD 2500	AL	<b>4052246</b>	7,8
		SKRD 3050	AL	<b>4052301</b>	8,9
<b>Rekkverksramme</b>			SKRDF 700	G	<b>8753000</b>
Med fjærlås					
<b>Rekkverksramme SKRA</b>		SKRA 500-700	G	<b>8751075</b>	4,4
					

**Forankring**

			Utfør.	Art. nr	Vekt
<b>Veggfestestag rør</b>		SVF 450x48	G	<b>8832046</b>	2,2
Krok 16 mm		SVF 600x48	G	<b>8832061</b>	2,6
Tillatt belastning 9,0 kN		SVF 900x48	G	<b>8832091</b>	3,7
Monteres med kopling fast 48x48		SVF 1200x48	G	<b>8832121</b>	4,8

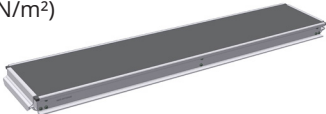
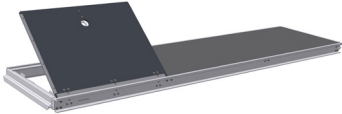
**Innplanking**

		Utfør.	Art. nr	Vekt
<b>Plan B=620 mm</b> Lastklasse 3 (2,0 kN/m <sup>2</sup> ) 	PL 700x620	AL	<b>4081077</b>	6,0
	PL 1250x620	AL	<b>4081127</b>	9,5
	PL 1655x620	AL	<b>4081167</b>	11,6
	PL 1964x620	AL	<b>4081197</b>	13,1
	PL 2500x620	AL	<b>4081257</b>	16,6
	PL 3050x620	AL	<b>4081307</b>	18,9
<b>Plan B=310 mm</b> Lastklasse 3 (2,0 kN/m <sup>2</sup> ) 	PL 1655x310	AL	<b>4082167</b>	7,7
	PL 1964x310	AL	<b>4082197</b>	8,9
	PL 2500x310	AL	<b>4082247</b>	11,3
	PL 3050x310	AL	<b>4082307</b>	13,4
<b>Lukeplan</b> Lastklasse 3 (2,0 kN/m <sup>2</sup> ) 	PLLU 1964x620	AL	<b>4081192</b>	14,8
	PLLU 2500x620	AL	<b>4081242</b>	17,4
	PLLU 3050x620	AL	<b>4081303</b>	20,2
<b>Stige</b> 	2100	AL	<b>2091210</b>	3,4

**Fotlister**





		Utfør.	Art. nr	Vekt
<b>Fotlist</b> Tre, gul transparent 	Gul m logo FL 3300x150x32		<b>2025331</b>	5,6
<b>Låsejern for fotlist</b> 		G	<b>1162002</b>	0,4







**Konsoller**

			Utfør.	Art. nr	Vekt
<b>Konsoll</b>		SK 300	G	<b>8775030</b>	3,9
Nøkkelvidde 22 mm		SK 700	G	<b>8775070</b>	7,9
		SK 800	G	<b>8775080</b>	9,1
<b>Konsoll AL</b>		SK 700 22 mm	AL	<b>4211072</b>	3,5
Konsoll SK 700 med og konsoll SK 650 uten spiretopp					
Nøkkelvidde 22 mm					

**Trapper**

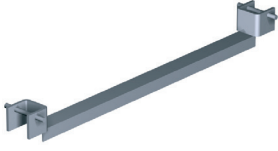
			Utfør.	Art. nr	Vekt
<b>UTV Trapp AL</b>		Låsesplint 12 mm		<b>2113100</b>	0,1
Med hvilplan og låsing		Gelender HL 2500x2000	AL	<b>4058245</b>	9,2
LxH 3050x2000 mm alt. 2500x2000 mm		Gelender HL 3050x2000	AL	<b>4058300</b>	10,3
Bredde 600 mm		Trapp UTV 1000	AL	<b>4102105</b>	11,2
		Trapp UTV 2500x2000	AL	<b>4102247</b>	22,9
		Trapp UTV 3050x2000	AL	<b>4102302</b>	29,2
		STS Gelenderstolpe 1000	G	<b>7015102</b>	4,2
		Feste til STS Gelenderstolpe UTV.AL	G	<b>7058300</b>	1,5
<b>UTV Trapp</b>		Trapp UTV 3050x2000	G	<b>2092200</b>	39,7
Med hvilplan og låsing		Låsesplint 12 mm		<b>2113100</b>	0,1
LxH 3050x2000 mm		Gelender HL 3050x2000	G	<b>2161300</b>	19,3
Bredde 600 mm		STS Gelenderstolpe 1000	G	<b>7015102</b>	4,2
		Feste for STS Gelenderstolpe - UTV	G	<b>8752001</b>	2,5
<b>Overgangsplate til UTV trapp</b>				<b>7211044</b>	3,6
For tetting av åpning mellom trapp og plan					
<b>Stillashenger</b>				<b>6265H00</b>	317,00
Stillashenger for rammestillas.					
Totalvekt 1300 kg					
Nyttelast 983 kg					

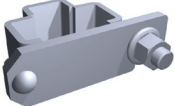
**Øvrige komponenter**

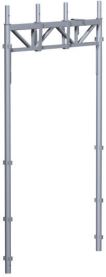
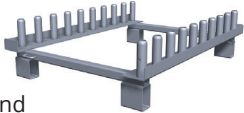
			Utfør.	Art. nr	Vekt
<b>Opplagsbjelke</b>		ULB 700	G	<b>8743700</b>	2,4
<b>Låsebjelke</b>		LSB 700	G	<b>8744701</b>	2,3
		LSB 0,7	G	<b>8744700</b>	2,3
<b>Tverrprofil</b> Nøkkelvidde 22 mm		TP 700	G	<b>8743701</b>	3,7
<b>Løs Bøylegruppe</b> For rekkverk ved hjørneløsninger Nøkkelvidde 22 mm			G	<b>8792000</b>	0,6
<b>Låseklammer rekkverk</b> For Rekkverk,, rørdiameter 38 mm Nøkkelvidde 22 mm			G	<b>8833000</b>	0,8
<b>Låsekrok</b> Til låsing av spireskjøt ved belastning, f.eks. ved løft eller inndekking. Ikke for hengende stillaser!			G	<b>8793000</b>	0,1
<b>Markramme</b> Med 2 faste og 2 skyvbare spirtopper Fag bredde 1460 mm			G	<b>8732201</b>	39,5
<b>Rammetainer</b> Til 20 stk. stående rammer Rammene surres til rammetainer med spennbånd			G	<b>8871000</b>	28,9

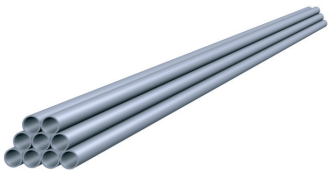

**Stillasrør**

		Utfør.	Art. nr	Vekt
<b>Stillasrør</b> 	SR 48-1000	G	<b>7241100</b>	4,1
	SR 48-1500	G	<b>7241150</b>	6,1
	SR 48-2000	G	<b>7241200</b>	8,0
	SR 48-2500	G	<b>7241250</b>	10,3
	SR 48-3000	G	<b>7241300</b>	12,4
	SR 48-3500	G	<b>7241350</b>	14,1
	SR 48-4000	G	<b>7241400</b>	16,7
	SR 48-4500	G	<b>7241450</b>	18,0
	SR 48-5000	G	<b>7241500</b>	20,1
	SR 48-6000	G	<b>7241600</b>	24,1



**Stillasrør Alu**



48,3x4 L=500	AL	<b>4241050</b>	0,8
48,3x4 L=1000	AL	<b>4241100</b>	1,5
48,3x4 L=1500	AL	<b>4241150</b>	2,3
48,3x4 L=2000	AL	<b>4241200</b>	3,0
48,3x4 L=3000	AL	<b>4241300</b>	4,5
48,3x4 L=4000	AL	<b>4241400</b>	6,0
48,3x4 L=6000	AL	<b>4241600</b>	9,0

**Rørkoblinger**

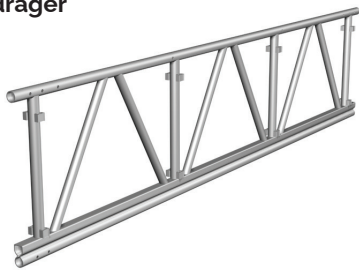
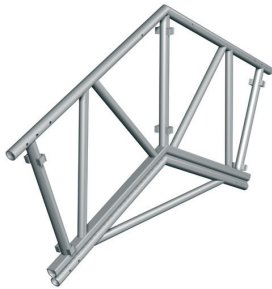
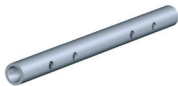
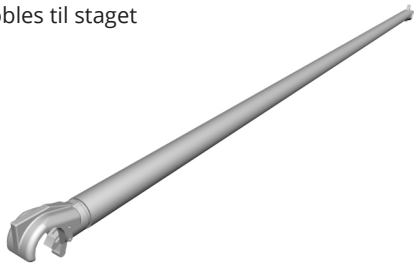

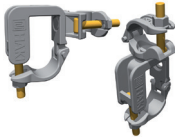
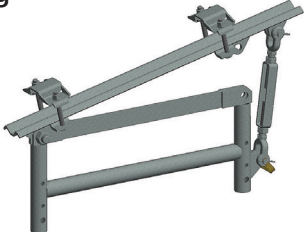

		Utfør.	Art. nr	Vekt
<b>Kobling fast</b> Nøkkelvidde 22 mm 	RA 48x48 22	G	<b>2048010</b>	1,2
	<b>Kobling variabel</b> Nøkkelvidde 22 mm 	SW 48x48 22	G	<b>2048011</b>
<b>Øvrige koblinger</b>		Kobling fast KF 48x60		<b>2042000</b>
	Kobling variabel KV 48x60		<b>2042001</b>	1,9
	Bjelkekobling SK 48 1-19	G	<b>2044000</b>	1,3
	Rørskjøt 48	G	<b>2045001</b>	1,3
	Støttepinne	G	<b>2045002</b>	0,6
	Kobling Grawlock	G	<b>2044004</b>	1,6
<b>Bøylekobling</b> 	Kpl 48	G	<b>2048017</b>	1,4

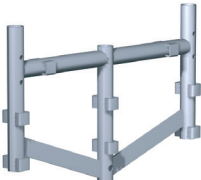
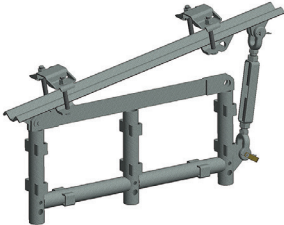
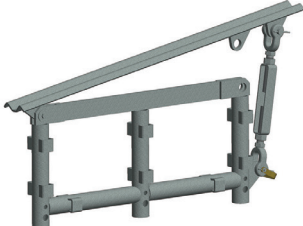

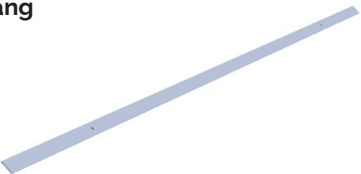
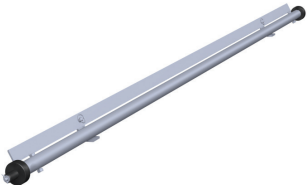
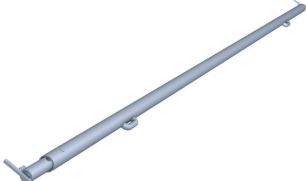

**HAKITEC 750 Værbeskyttelse**

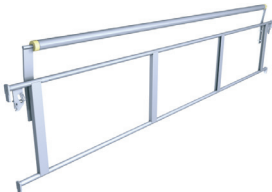
		Utfør.	Art. nr	Vekt
<b>750 Fagverksdrager</b> 	1250	AL	<b>4032125</b>	9,4
	2250	AL	<b>4032225</b>	16,6
	3250	AL	<b>4032325</b>	23,9
	6250	AL	<b>4032625</b>	46,0
<b>750 Fagverksvinkel</b> 	15°	AL	<b>4202260</b>	18,3
	22,5°	AL	<b>4202261</b>	17,6
	37,5°	AL	<b>4202267</b>	18,0
<b>750 Skjøterør</b> 		G	<b>7203001</b>	2,0
<b>750 Diagonalstag</b> Rørdiameter 53 mm OBS! Normal rørkopling 48 mm kan ikke kobles til staget 	1250x1250	AL	<b>4122121</b>	2,7
	1250x2000	AL	<b>4122123</b>	4,0
	1250x2250	AL	<b>4122124</b>	4,0
	1655x1250	AL	<b>4122162</b>	3,4
	1655x2000	AL	<b>4122163</b>	3,3
	1655x2250	AL	<b>4122164</b>	4,0
	1964x1250	AL	<b>4122192</b>	3,7
	1964x2000	AL	<b>4122193</b>	4,3
	1964x2250	AL	<b>4122194</b>	4,6
	2500x1250	AL	<b>4122249</b>	4,4
	2500x2250	AL	<b>4122253</b>	5,1
	2500x2000	AL	<b>4122254</b>	4,9
	3050x1250	AL	<b>4122299</b>	5,0
3050x2000	AL	<b>4122303</b>	5,5	
3050x2250	AL	<b>4122304</b>	5,6	
<b>750 Rekkverksstolpe</b> 		G	<b>7203322</b>	10,5



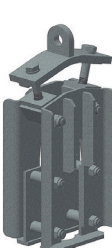

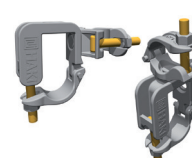



		Utfør.	Art. nr	Vekt
750 Kopling vridbar	vert. 48	G	<b>2048007</b>	1,8
	hor. 48	G	<b>2048008</b>	1,8
				
750 Fagverksopplag		G	<b>7203335</b>	16,8
750 Klembeslag		G	<b>5231617</b>	1,6
750 Fagverksopplag		G	<b>7203325</b>	16,8
750 Bunnramme		G	<b>7203320</b>	10,4
750 Fagverksopplag/bunnramme med to klembeslag		G	<b>7203336</b>	22,5
750 Fagverksopplag/bunnramme uten klembeslag		G	<b>7203326</b>	22,5

		Utfør.	Art. nr	Vekt
<b>750 Fasthjul med spor</b>		G	<b>7142003</b>	9,9
<b>750 Krok løftesikring</b>		G	<b>7175049</b>	3,1
	Skrue M6S M12x40	G	<b>6130323</b>	0,0
	Mutter M12 Nylon	Fzb	<b>6130208</b>	0,0
<b>750 Krok løftesikring for justerbart hjul</b>		G	<b>7175062</b>	10,0
<b>U-profil løftesikring</b>				
	3000	G	<b>7175050</b>	16,0
	2000	G	<b>7175051</b>	10,6
	Skrue M6S M12x40	G	<b>6130282</b>	0,0
	Mutter M12 Nylon	Fzb	<b>6130267</b>	0,0
<b>750 Triangelbjelke</b>				
	2000	G	<b>7203332</b>	31,7
	3000	G	<b>7203333</b>	44,0
<b>Triangelkopling</b>				
	Overdel	G	<b>2044100</b>	1,3
	Underdel	G	<b>2044101</b>	0,7
<b>750 Endestykke til Fagverksdager</b>		G	<b>7203337</b>	6,9
<b>750 Monteringsplan</b>				
	2000	AL	<b>7500004</b>	14,5
	2250	AL	<b>7500005</b>	16,3

		Utfør.	Art. nr	Vekt
<b>750 Trekkestang</b> 	1250	G	<b>7500012</b>	2,5
	1655	G	<b>7500026</b>	3,6
	2500	G	<b>7500007</b>	5,5
	3050	G	<b>7500006</b>	6,8
<b>750 Åk for trekking av duk</b> For dukmontering 	1250	G	<b>7500011</b>	7,8
	1655	G	<b>7500025</b>	9,4
	1964	G	<b>7500017</b>	10,6
	2500	G	<b>7500009</b>	12,6
	3050	G	<b>7500008</b>	14,8
<b>750 Dukstrekker</b> 	1250	G	<b>7500013</b>	5,9
	1655	G	<b>7500027</b>	7,6
	1964	G	<b>7500040</b>	7,0
	2500	G	<b>7500014</b>	10,6
	3050	G	<b>7500015</b>	12,9
<b>750 Dukstrekkerør</b> 	1250	G	<b>7500024</b>	4,3
	1655	G	<b>7500028</b>	5,9
	1964	G	<b>7500042</b>	5,6
	2500	G	<b>7500023</b>	9,2
	3050	G	<b>7500022</b>	11,3
<b>750 Ramme med rulle for møne</b> 	1250	G	<b>7500018</b>	11,2
	1655	G	<b>7500019</b>	13,9
	1964	G	<b>7500041</b>	16,0
	2500	G	<b>7500020</b>	17,9
	3050	G	<b>7500021</b>	20,5
<b>750 Skinne møne</b> Takvinkel 15°, 22,5° alt. 37,5° Uten montert 7540001 Skjøtepinne AL Merket med art. nr i en ende 	15°	AL	<b>7541015</b>	2,8
	22.5°	AL	<b>7541022</b>	2,8
	37.5°	AL	<b>7541037</b>	3,0
<b>750 Skinne</b> L=1250, 2250, 3250 og 6250 mm Med 7540001 Skjøtepinne AL montert i øvre enden Merket med art. nr i øvre enden 	1250	AL	<b>7541125</b>	2,6
	2250	AL	<b>7541225</b>	4,7
	3250	AL	<b>7541325</b>	6,7
	6250	AL	<b>7541625</b>	12,9

		Utfør.	Art. nr	Vekt
<b>750 Skinne takfot</b> Takvinkel 15°, 22,5° alt. 37,5° Med 7540001 Skjøtepinne AL monterert i øvre ende Merket med art. nr. i øvre ende		AL	<b>7541150</b>	3,3
		AL	<b>7541220</b>	3,3
		AL	<b>7541370</b>	3,3
<b>750 Trak Feste for fallsikring</b>		G	<b>7541006</b>	7,6
<b>750 Feste for fallsikring - Komplet</b> For HAKITEC 750 med HAKI Trak Med skinne møne takvinkel 15° alt. 22,5°			<b>7541007</b>	10,4
			<b>7541008</b>	10,4
<b>750 Rullekonsoll</b> Til montering av presenning		G	<b>7500010</b>	7,4
<b>750 Vridbar kopleing SW</b> Nøkkelvidde 22 mm Til spesialprofilen på fagverksdrager 750 AL		vert. 48	G <b>2048007</b>	1,8
		hor. 48	G <b>2048008</b>	1,8
<b>750 Skjøtelås</b>		G	<b>7540000</b>	0,2
<b>750 Skjøtepinne</b>		AL	<b>7540001</b>	0,01

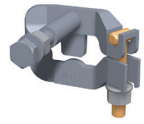

		Utfør.	Art. nr	Vekt
<b>750 Skjøtepakning</b>			<b>7540002</b>	0,1
<b>750 Spennbånd</b>		3 m 450 kg	<b>7540003</b>	0,5
<b>750 Skinnefeste</b>			Fzb <b>7541000</b>	0,5
<p>Monteres til fagverk 750 AL med 1 stk            2113100 Låsesplint 12 mm            OBS! 2112000 Låsesplint med fjær 12 mm anbefales ikke for denne montasjen</p>				
<b>750 Skinnefeste kopling</b>				
<b>750 Skinnefeste takfot</b>			Fzb <b>7541002</b>	1,3
<p>Monteres til fagverk 750 AL med 1 stk            2113100 Låsesplint 12 mm            OBS! 2113000 Låsesplint med fjær 12 mm anbefales ikke for denne montasjen</p>				
<b>Ringnøkkel</b>		19 22	<b>2051019</b> <b>2051021</b>	0,3 0,3
<p>Med sperre</p>				
<b>Skinnefeste kopling</b>			<b>2048030</b>	1,0
<p>Nøkkelvidde 22 mm</p>				
<b>Skinnefeste bøyle</b>			Fzb <b>7541003</b>	1,0
<p>Med bøylefeste            Nøkkelvidde 22 mm</p>				
<b>Styring Trak duk</b>			G <b>7541005</b>	1,1
<p>For dukmontering</p>				

**HAKI Trak duk**

Utfør.    Art. nr    Vekt

**HAKI Trak duk**

PVC belagt polyesterrev

Med kederlist

Produseres fra gang til

gang i lengde og bredde

Flammehemmende iht Euroclass

13501-1: B-s2,d0

**HAKI Trak gavelkappe**

Med kederlist på en side

Bredde 935 mm

OBS! Dekker kun fagverk

Flammehemmende iht Euroclass

13501-1: B-s2,d0

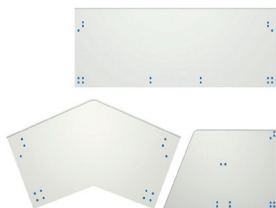
**HAKITEC INNDEKKNING**
**HAKI flammehemmende duker og nett**

Utfør.    Art. nr    Vekt

**HAKITEC 320 FR takduk**

3,3 x 40 m

**2034048**

41,0

 Armert plastduk, 320 g/m<sup>2</sup>

Euroclass 13501-1: B-s3,d0

**HAKITEC 240 FR**

3,2 x 30 m

**2034049**

23,0

 Armert plastduk, 240 g/m<sup>2</sup>

Euroclass 13501-1: B-s3,d0

**HAKITEC 180 FR**

3,2 x 30 m



**2034050**

18,0

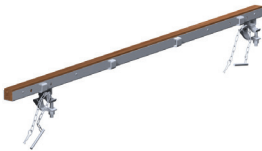
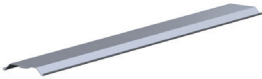

Euroclass 13501-1: B-s3,d0

		Utfør.	Art. nr	Vekt
<b>Fasadenett 140 FR</b> 140 g/ m <sup>2</sup> Euroclass 13501-1: B-s3,d0	3,1 x 50 m		<b>2034051</b>	22,0
<b>Fasadenett 80 FR</b> 80 g/ m <sup>2</sup> Euroclass 13501-1: B-s3,d0	3,1 x 50 m		<b>2034052</b>	13,0

**Innfestning HAKITEC duk**

		Utfør.	Art. nr	Vekt
<b>Dukspenner</b> Beregn en dukspenne pr. 1,5 m <sup>2</sup> dekket fasatareal Dukspenner leveres 100/pakke	Dukspenne Dukspenne lett		<b>2032100</b> <b>2032300</b>	0,03 0,01
				
<b>Festebjelke</b> Nøkkelvidde 22 mm	950 22 mm 1900 22 mm		<b>7207096</b> <b>7207191</b>	5,0 8,0
				
<b>Dekkplate HAKITEC</b> Beregn 6 stk byggplateskruer pr. dekkplate, samt 2 stk pr. møneplate Byggplateskrue leveres 250/pakke	Byggplateskrue BTL 4,8x35 Dekkplate 1900 Møneplate 15		<b>2114000</b> G <b>7251200</b> G <b>7252001</b>	0,0 3,3 0,8
				
<b>Dukstrekker til møne 750</b> For HAKITEC duk i 750 tak	Dukstrekker 2500 Dukstrekker 3050	G G	<b>7213245</b> <b>7213300</b>	10,3 11,6
				

**Stillasetak**

		Utfør.	Art. nr	Vekt
<b>Stillastak</b>	Takbøyle stillas	G	<b>7014001</b>	18,0
Takbøyle = Fagbredde 700-770 mm	Forlengelsesrør for takbøyle	G	<b>7014002</b>	3,5
Takbøyle + 1 stk.forlengelsesrør = Fagbredde 1050-1250 mm				
Takbøyle + 2 stk. forlengelsesrør = Fagbredde 1655 mm				
Som dukstøtte mellom takbøylene brukes rekkverksramme eller lengdebjelke				
<b>Takbøyle stillastak</b>		G	<b>7014003</b>	7,0
For montasje direkte på en spiretopp				
Som forlengning brukes en spire, maksimalt spire S 1000				
Største bredde på stillastaket 1275 mm				

## Register

450 Diagonalstag teleskopisk	35
450 Endestykke til Fagverksdager	35
450 Fagverksdrager	35
450 Fagverksdrager m/bøyler	35
450 Mønerulle	37
450 Opphengsbeslag LB	36
450 Skinne	37
450 Skinne takfot	37
450 Skjøterør	35
450 Skjøterør takfot	35
450 Veggstolpe	36
750 Bunnramme	45
750 Diagonalstag	44
750 Dukstrekker	47
750 Dukstrekkerør	47
750 Endestykke til Fagverksdager	46
750 Fagverksdrager	44
750 Fagverksopplag	45
750 Fagverksopplag	45
750 Fagverksopplag/bunnramme med to klembeslag	45
750 Fagverksopplag/bunnramme uten klembeslag	45
750 Fagverksvinkel	44
750 Fasthjul med spor	46
750 Feste for fallsikring - Komplet	48
750 Klembeslag	45
750 Kopling vridbar	45
750 Krok løftesikring	46
750 Krok løftesikring for justerbart hjul	46
750 Monteringsplan	46
750 Ramme med rulle for møne	47
750 Rekkverksstolpe	44
750 Rullekonsoll	48
750 Skinne	47
750 Skinnefeste	49
750 Skinnefeste kopling	49
750 Skinnefeste takfot	49
750 Skinne møne	47
750 Skinne takfot	48
750 Skjøtelås	49
750 Skjøtepakning	49
750 Skjøtepinne	48
750 Skjøterør	44
750 Spennbånd	49
750 Trak Feste for fallsikring	48
750 Trekkestang	47

750 Triangelbjelke	46
750 Vridbar kopling SW	48
750 Åk for trekking av duk	47
Adapter	18
Adaptor Tripod	18
AL plank B=170 mm	6
AL plank B=200 mm	32
AL plank B=230 mm	6
AL plank B=295 mm	32
AL plank B=320 mm	32
Alu rampe	7
Belysningskonsoll	34
Beslag skyvbar grind	17
Bjelkerytter	15
Bjelkerytter	23
Bjelkerytter dobbel	15
BRS Bjelkerytter	15
Bunnskrue	3
Bunnskrue	33
Bunnskrue	38
Bunnskrue for S6 spirer	23
Bunnskrue leddet	14
Bunnskrue leddet 750	14
Bunnspiss	14
Bøylegruppe løs	33
Bøylekobling	43
Dekkplate AL	16
Dekkplate B=230 mm	7
Dekkplate HAKITEC	51
Dekkplate stål	16
Diagonalstag	22
Diagonalstag DS	4
Diagonalstag for trall/labanklemmer	4
Dukspenner	51
Dukstrekker til møne 750	51
Enkelbjelke	14
Enkeltbjelke	19
Enkeltbjelke	36
Enrørsbjelke	3
Enrørsbjelke	21
Fagverksdrager	10
Fasadenett 14/ 80 FR	51
Festebjelke	51
Forsterkningsdetalj	36
Fotlist	8
Fotlist	8

Fotlist	8
Fotlist	8
Fotlist	40
Fotlistbeslag	8
Fotlistbeslag	40
Fotlist i ubehandlet tre	40
Fotlist teleskopisk	8
HAKI Galge	19
HAKI Offshore galge	20
HAKI Sikkerhetsblokk	20
Hakitainer	19
HAKITEC 320/ 240/180 FR takduk	50
HAKI Trak duk	50
HAKI Trak gavelkappe	50
HBS Diagonalstag	30
HBS Enrørsbjelke med skrulås SBF	30
HBS Horisontalstag	30
HBS H-Profil kledningsprofil	31
HBS Kledningspanel	31
HBS Låsklamme Kledningsprofil	31
HBS Nedre Bjelke	31
HBS Pilar	30
HBS Sidestag	30
HBS Splint	32
HBS Tripod Topadapter inkl. klembeslag	32
HBS Tåreplateplank	30
HBS U-Profil Kledningsprofil	30
HBS Øvre Bjelke	31
Hjul	17
Hjul for tak	36
Hjørnekonsoll	9
Hjørnekonsoll	10
Horisontaldiagonal HDS	5
Horisontaldiagonal HDS	22
Horisontaldiagonal teleskopisk HDS	22
Hvilplan VLP	27
Høydeinnstillingsspire	14
Innstegstrapp	11
Justerbar Bunnkrue 60	18
Kombikonsoll KK	10
Kombinasjonsbeslag	17
Kombinasjonsbeslag	19
Komposittlem	6
Kompositteggfeste	5
Kompositteggfeste	39
Konsoll	22

Konsoll	22
Konsoll	41
Konsoll AL	41
Konsolldiagonal	9
Konsolldiagonal	23
Konsolldiagonal S6 AL	25
Konsoll justerbar	9
Konsoll med spireskjøt	9
Konsoll med spireskjøt S6 AL	25
Konsoll uten spireskjøt	9
Kopling fast	33
Kopling fast	43
Kopling vridbar	43
Krokplan	7
Lengdebjelke	3
Lengdebjelke	21
L-ramme	38
Lukeplan	40
Lukeplan AL B=690 mm	6
Låsebeslag for hjul	36
Låsebjelke	42
Låsefjær	20
Låsefjær til bunnskrue	14
Låsejern for fotlist	8
Låseklammer rekkverk	15
Låseklammer rekkverk	42
Låsekrok	42
Låselist	23
Låsesplate	23
Låsesplint	18
Låsesplint for offshore med kjetting	18
Låsesplint m/fjær	18
Løs Bøylegruppe	15
Løs Bøylegruppe	42
Markramme	42
Monteringsverktøy for rekkverk	19
Monteringsverktøy låsefjær	20
Motvekt	33
Opplagsbjelke	42
Overgangsplate til UTV trapp	41
PAS Diagonal	29
PAS Enrørsbjelke m dekkplate	29
PAS Gelender	28
PAS Gelender	29
PAS Gelender innsteg	29
PAS Rekkverk	29



PAS Trappevange	29
PAS Trappevange	29
Plan B=310 mm	40
Plan B=620 mm	40
Plankerytter	17
Plankerytter	17
Ramme 500	38
Ramme 500 AL	38
Ramme 800	38
Ramme 800 AL	38
Ramme 1000	38
Ramme 1000 AL	38
Ramme 2000	38
Ramme 2000 AL	38
Ramme med fotlist	38
Ramme med fotlist	38
Rammetainer	42
Rekkverksgrind	33
Rekkverksgrind med nett SGF	4
Rekkverk SKR	4
Rekkverksramme	22
Rekkverksramme	39
Rekkverksramme AL	39
Rekkverksramme GFL	4
Rekkverksramme GFL	39
Rekkverksramme SKRA	39
Rekkverksstolpe	16
Rekkverksstolpe	26
Rekkverksstolpe SRS	16
Rekkverksstolpe SS	16
Ringnøkkel	49
SGT Rekkverksramme Trappetårn	27
Sikkerhetsbøyle	16
Skinnefeste bøyle	49
Skinnefeste kopling	49
Sparkebord	33
Spireholder	15
Spireholder	15
Spireholder S4 AL	23
Spireholder S6 AL	25
Spire S	3
Spire S4 AL	21
Spire S6 AL med splint	24
Splint til spireskjøt	3
Splint til spireskjøt	21
SS Klembeslag	13

SS Monteringsverktøy til hengende	13
SS Opphengsbeslag Bulb-Kjetting	12
SS Opphengsbeslag Bulb-Kjetting	12
SS Opphengsbeslag Bulb-Rør	13
SS Opphengsbeslag Gallerdørk	12
SS Opphengsbeslag H-bjelke	12
SS Opphengsbeslag KF 48 dobbel	13
SS Opphengsbeslag kjetting	13
SS Opphengsbeslag L-bjelke	12
STC Fotlist	28
STC Gelender komplett	28
STC Gelender øvre	28
STC Innstegsbjelke	28
STC Innstegstrapp	28
Stige	40
Stige ST	6
Stillasbukk	19
Stillashenger	41
Stillashjul S6	25
Stillaskjetting med to sjakler	13
Stillaslem Alu	6
Stillasnett 125 FR	51
Stillasrør	43
Stillasskilt	20
Stillastak	17
Stillastak	18
Stillastak	52
Stillastau	20
Stolseksjon	33
STS Fotlist	26
STS Gelender	26
STS Gelenderstolpe	26
STS Gelenderstolpe	27
STS Hvilplan	26
STS Innstegstrapp	27
STS Låsekrok	27
STS Rekkverksgrind	26
STS Rekkverksramme	27
STS Rekkverksramme Trappetårn	27
STS Trappeløp	26
STV Stige med hvilplan	12
Styring Trak duk	49
Takbøyle stillastak	52
Takfotsbeslag	36
Testnøkkel til forankring 350Nm	20
Toppgafler	18

Topplate Tripod	18
Toppspire S4 AL	21
Toppspire S6 AL	24
Toppspire SC	14
Trappeløp TRP	27
Trekantplatninger	7
Triangelkopling	46
Tribunekonsoll	33
Tripod	18
Tverrbjelkebeslag	17
Tverrprofil	42
U-profil løftesikring	46
Utfyllingsplater AL	16
UTV Gelender indre	11
UTV Gelender HL	11
UTV Trapp	11
UTV Trapp	41
UTV Trapp AL	11
UTV Trapp AL	11
UTV Trapp AL	41
Veggfesteboyle	39
Veggfeste justerbart	5
Veggfestestag	39
Veggfestestag rør	39
Veggfestestag rør SVF	5
Veggstag VST	5
Øvrige koplinger	43
Øyeskrue	20

